

4G/5G Sharkfin MiMo Antenna

GPSD-6-60[-VAR]

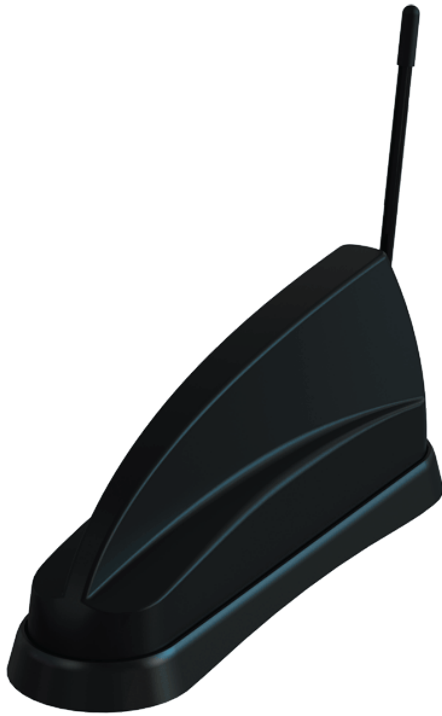

- OEM style sharkfin with 2x2 MiMo for 4G/5G
- GPS/GNSS and optional up to 4x MiMo WiFi
- Support for external whip

The GPSD 'Sharkee' range has become a byword for industry leading technology in a discrete OEM style shark fin housing. The GPSD-6-60 brings 5G capability to the GPSD family.

The antenna should be installed on a metal panel when a comms whip is used, but if whip is not required, then it may be fitted on a non-metallic panel and still offer similar performance.

The shark fin housing contains a 2x2 MiMo antenna function for 4G/5G (617-960/1710-6000MHz) and option of 2x2, 3x3 or 4x4 MiMo dual band WiFi, which supports WiFi 6. An active antenna for GPS/GLONASS/Galileo/ BeiDou is included, with 26dB gain LNA and advanced filtering for LTE Band 13/14 operation. In addition, there is an integral stud mount for an external antenna whip that can support a range of VHF, UHF or 700/800MHz antennas. A blanking cap is supplied for when this is not required.

The GPSD shark fin design provides multiple antenna functions while remaining discreet and is suitable for public safety (overt/covert), industrial and transport applications where a cost effective, efficient and robust antenna is essential. Requiring only a single hole mounting, the GPSD reduces vehicle damage, installation time & cost and visual impact whilst protecting a vehicle's resale value.

Technical Drawing

GPSD-6-60-QW Shown

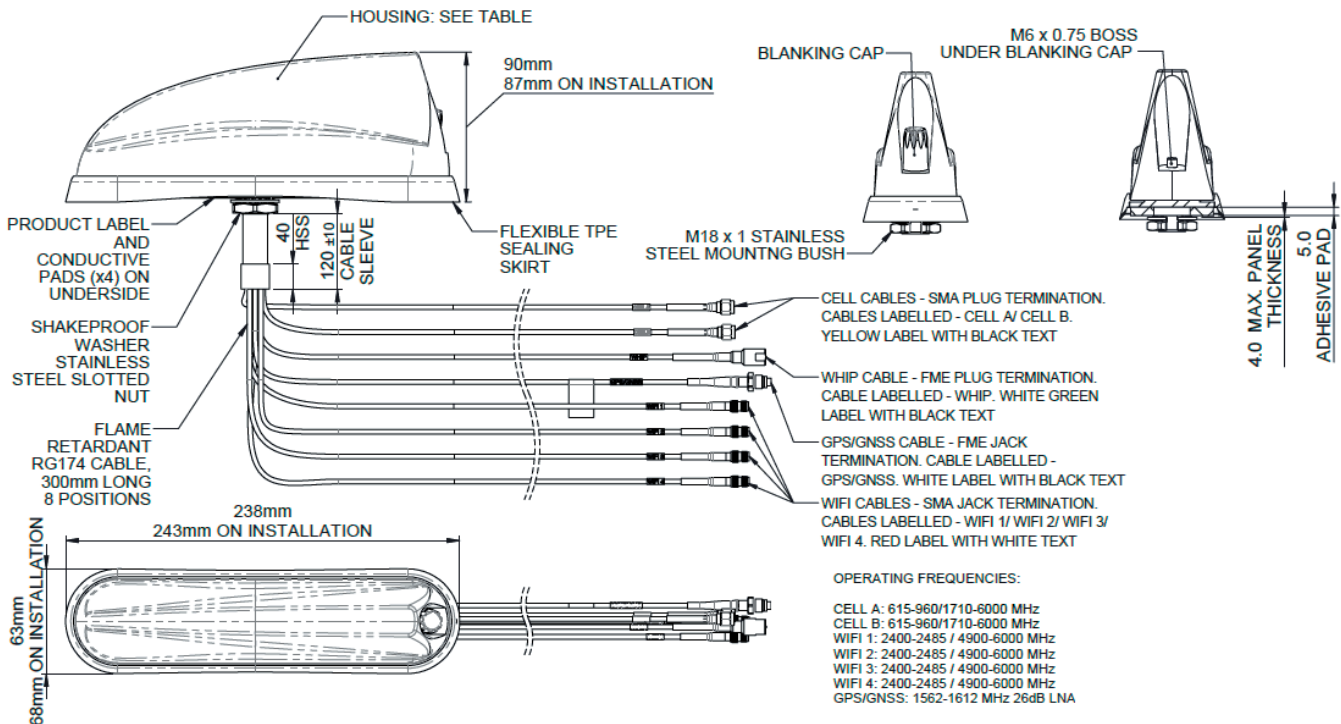

4G/5G Sharkfin MiMo Antenna

GPSD-6-60[-VAR]

PANORAMA ANTENNAS

Product Data

Part No.	GPSD-6-60-QW				GPSD-6-60-TW				GPSD-6-60-DW				GPSD-6-60				
Electrical Data																	
Frequency Range (MHz)	Element 1	1562-1612															
	Elements 2 & 3	2x 617-960, 1710-6000															
	Elements 4, 5 6 & 7	4 x 2.4/5.0/7.1GHz				3 x 2.4/5.0/7.1GHz				2 x 2.4/5.0/7.1GHz				-			
	Whip	Dependent on selected whip															
Peak gain: Isotropic*	Element 1	5dBi (617-960MHz)															
	Elements 2 & 3	8dBi (1710-3800MHz)															
		9dBi (4900-6000MHz)															
	Elements 4, 5, 6 & 7	5dBi (2396-2485MHz)				5dBi (2396-2485MHz)				5dBi (2396-2485MHz)				-			
		11dBi (4900-7200MHz)				11dBi (4900-7200MHz)				11dBi (4900-7200MHz)				-			
Isolation**	4G/5G	>12dB															
	WiFi	> 15dB				> 15dB				> 15dB				-			
Typical Efficiency* W/o Cable Loss	Elements 2 & 3	> 40% (617-698Mz) >60% (698-960/1710-6000MHz)															
Correlation Co-efficient	Elements 2 & 3	<0.2															
Polarisation		Vertical															
Pattern		Omni-directional															
Impedance		50Ω															
Max Input Power (W)		Internal elements 10W / main whip 60W															
GPS/GNSS Data																	
Frequency Range (MHz)	1562-1612																
VSWR	<2:1 ± 4MHz																
Gain: LNA	26dB																
Polarisation	Right Hand Circular																
Out of Band Rejection	>40dB (+/- 100MHz f) Notch Filter @787MHz - 23dB																
Operating Voltage	3-5V DC (fed via coax)																
Current	Typical <20mA																
Mechanical Data																	
Dimensions (mm) - Installed	Total Height (excl whip)	90 (3.54")															
	Length	243 (9.56")															
	Width	63 (2.48")															
Operating Temp (°C)	-40° / +80°C (-40° / 176°F)																
Material	ASA, Silicone Rubber, Aluminium Alloy																
Colour	Black																
Ingress Protection	IP69K																
Mounting Info																	
Fixing	Panel Mount																
Hole Size (mm)	19 (3/4")																
Cable Data																	
Cable Type - All Feeds	FR RG174 (UN ECE R 118 Compliant)																
Dimensions (mm)	Diameter	2.8 (0.11")															
	Length	300 mm (12")															
	Whip	FME (m)															
Termination	GPS/GNSS	FME (f)															
	4G/5G	2 x SMA plug															
	WiFi	4x SMA (f)				3x SMA (f)				2x SMA (f)				-			

4G/5G Sharkfin MiMo Antenna

GPSD-6-60[-VAR]

Electrical Data on
Ground Plane - Cell

Typical VSWR*

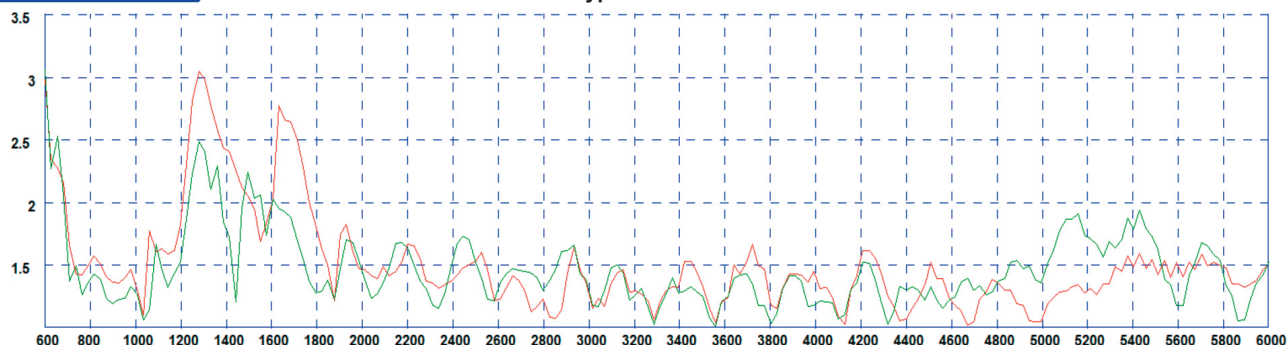

*VSWR elements 1&2 measured on 600x600mm (2'x2') ground plane without additional cable

Typical Swept Peak Gain **

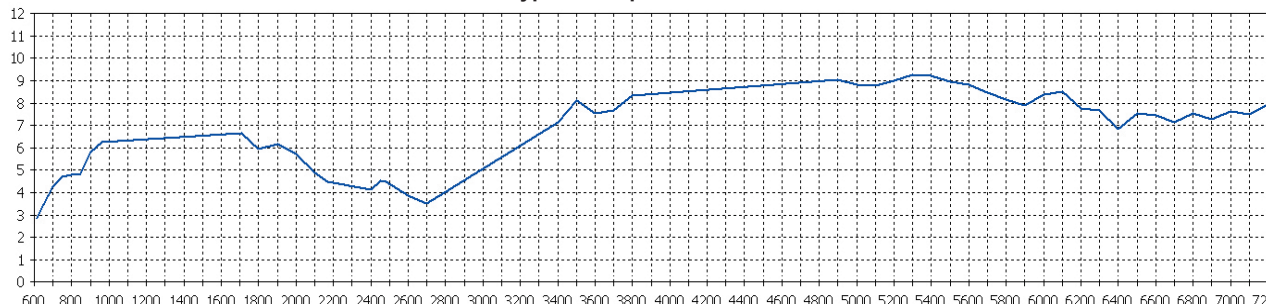

**Swept peak gain simulated in CST Microwave Studio with all elements fed together without cable loss on 600x600mm (2'x2') ground plane

Typical Efficiency ***

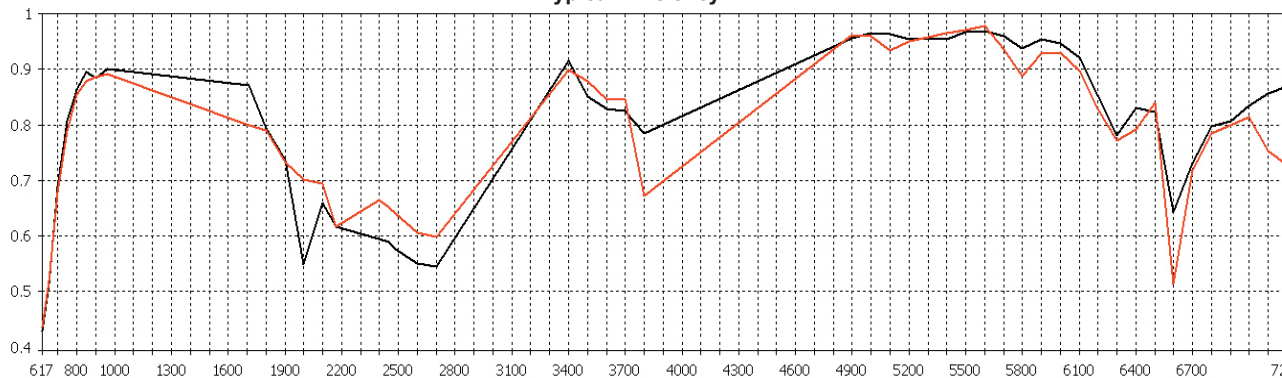

***Efficiency simulated in CST Microwave Studio with all elements fed together without cable loss on 600x600mm (2'x2') ground plane

Typical Isolation ***

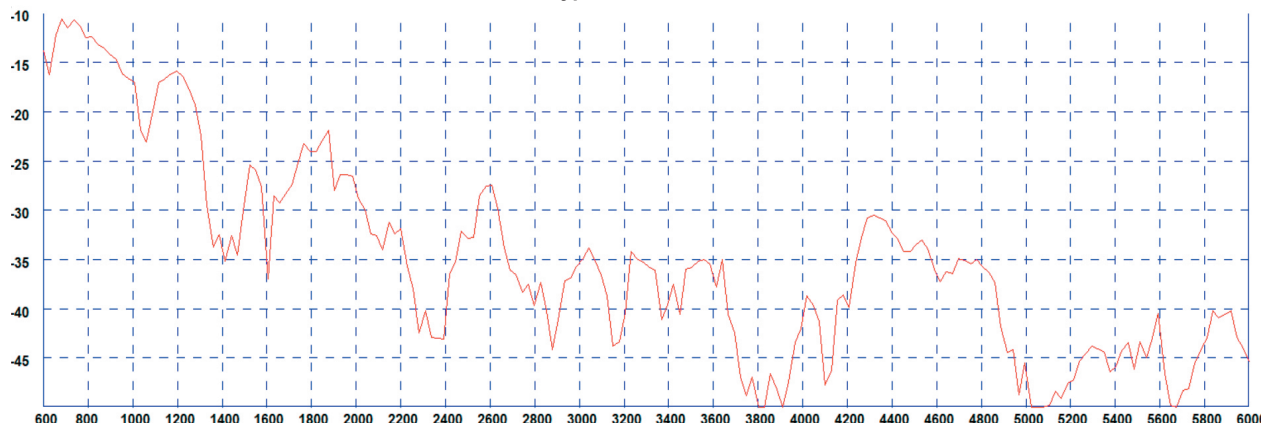

***Typical isolation measured on a 600x600mm (2'x2') ground plane without cable loss

4G/5G Sharkfin MiMo Antenna

GPSD-6-60[-VAR]

Electrical Data -on
groundplane - WiFi

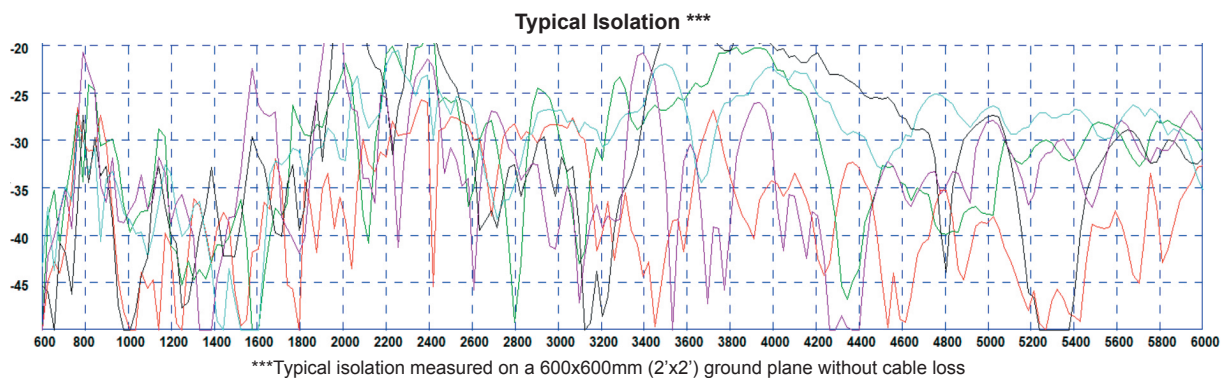
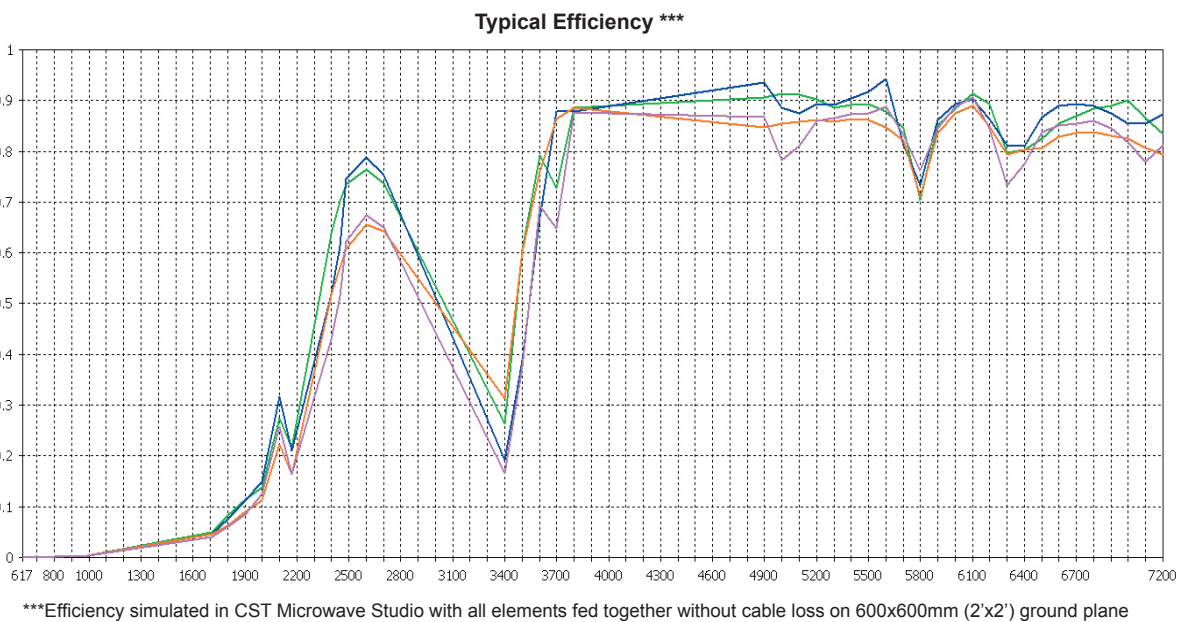
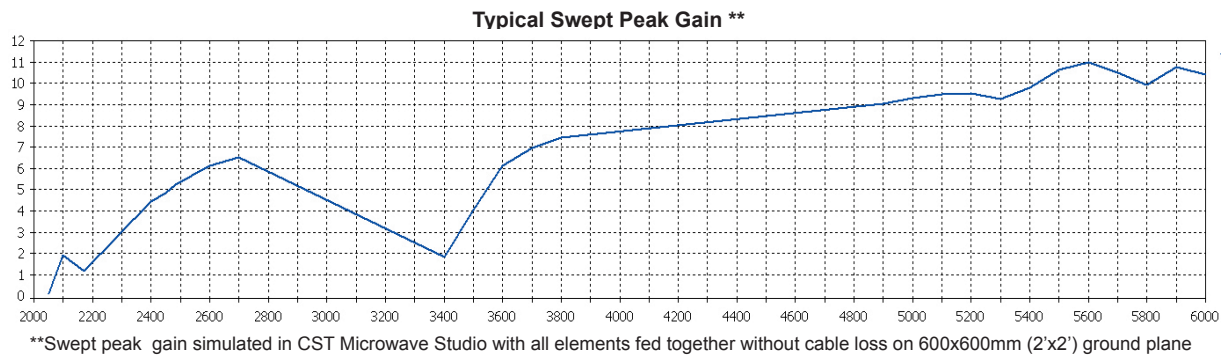
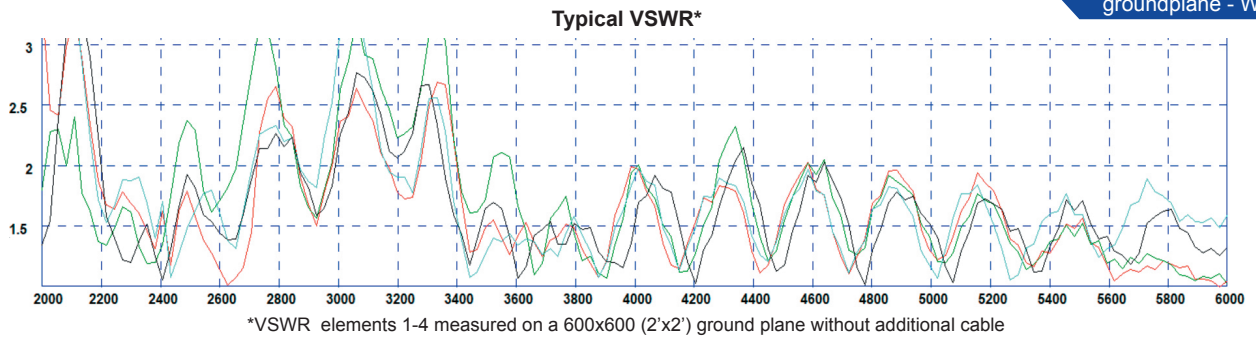

4G/5G Sharkfin MiMo Antenna

GPSD-6-60[-VAR]

Electrical Data in
Free Space - Cell

Typical VSWR*

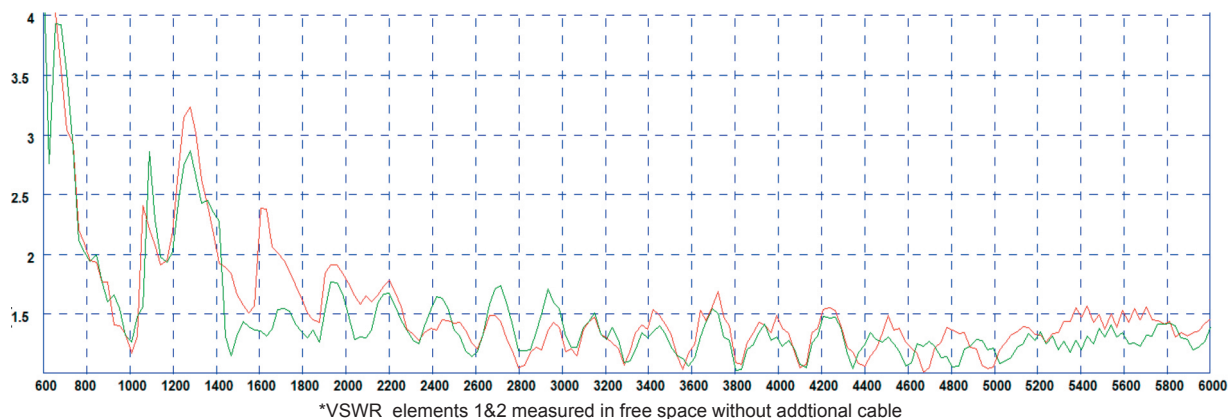

Typical Swept Peak Gain **

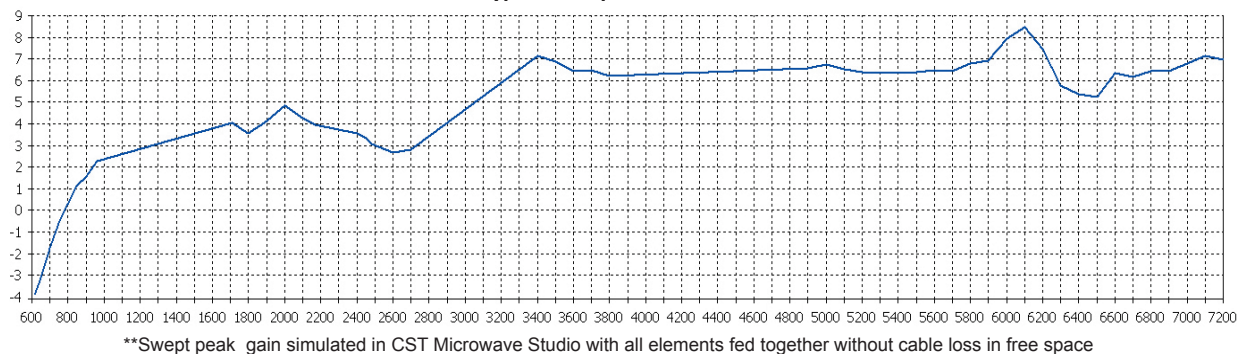

Typical Efficiency ***

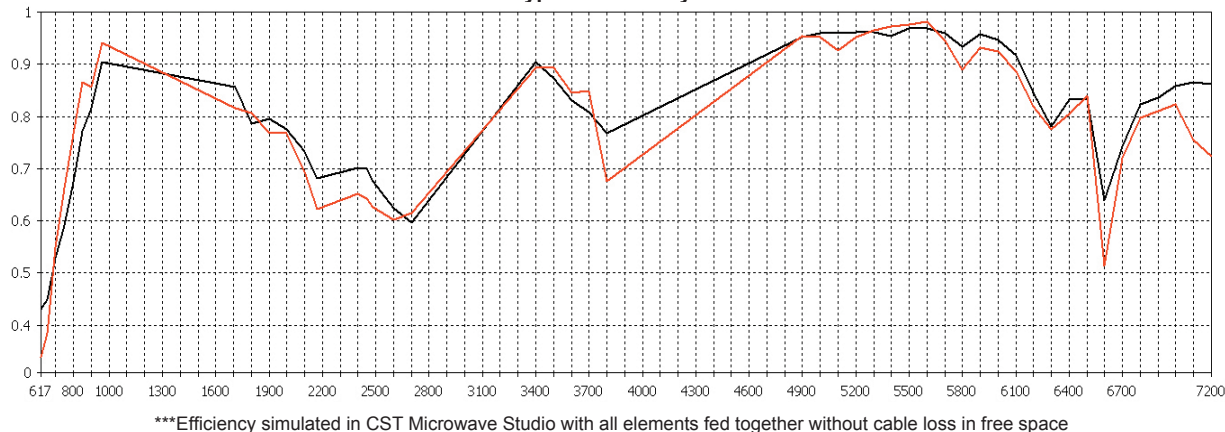

Typical Isolation ***

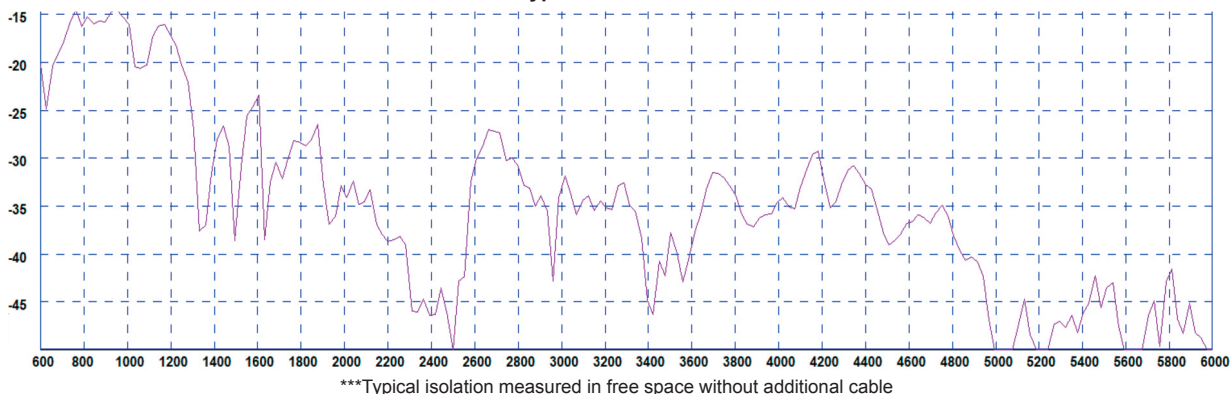

4G/5G Sharkfin MiMo Antenna

GPSD-6-60[-VAR]

Electrical Data -in
Free Space - WiFi

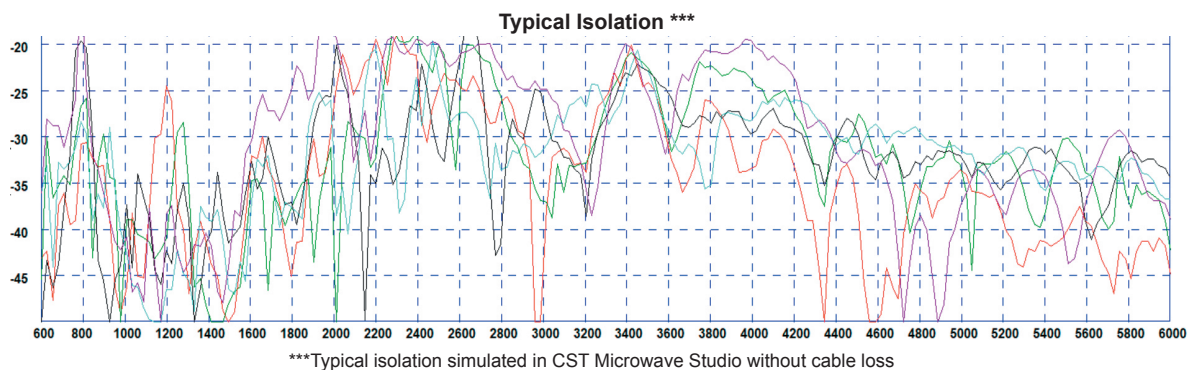
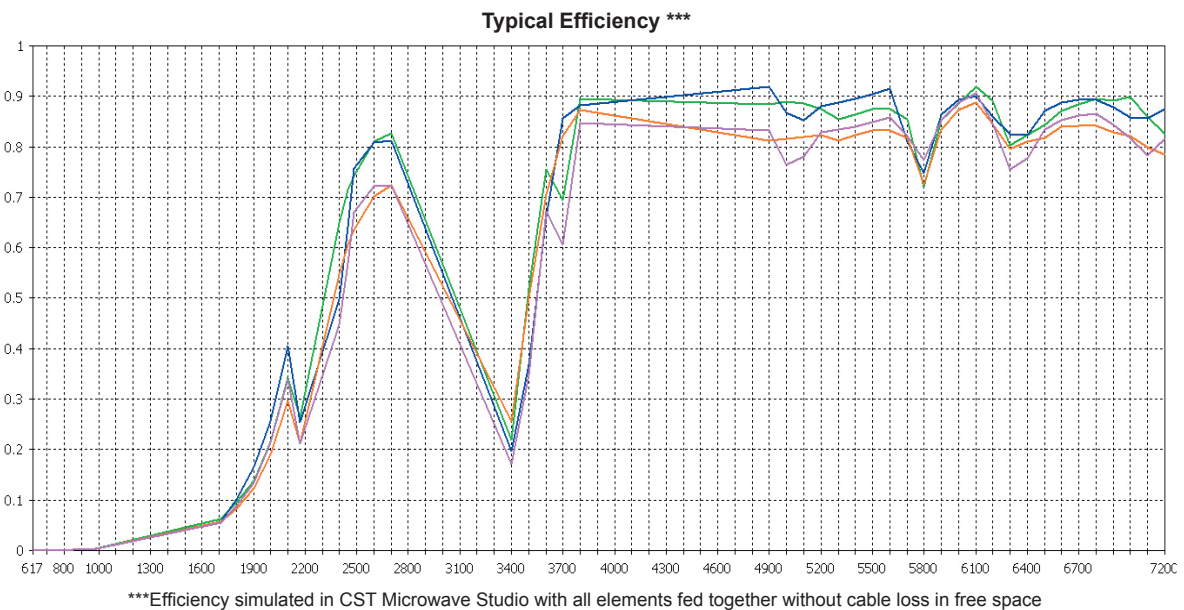
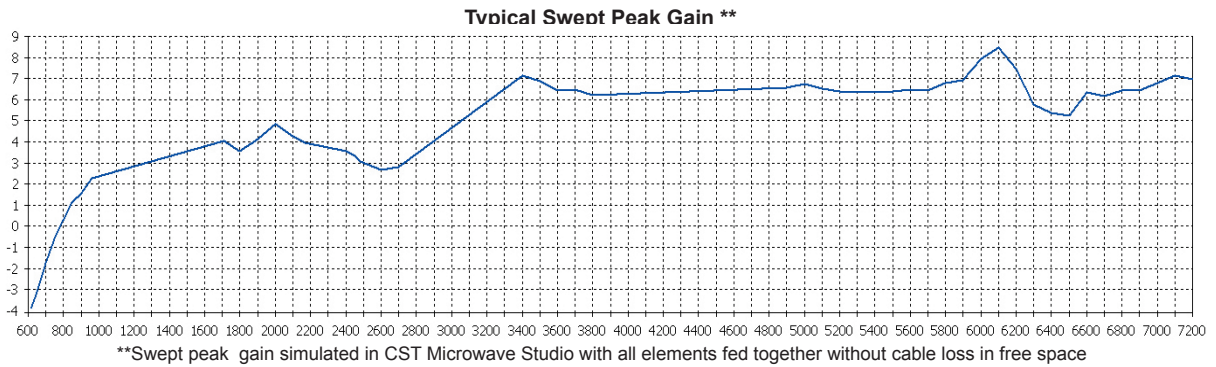
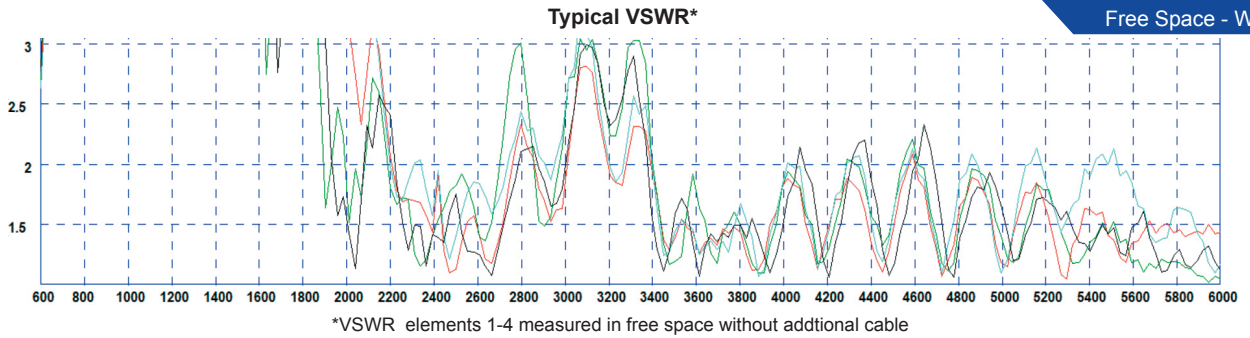

4G/5G Sharkfin MiMo Antenna

GPSD-6-60[-VAR]

3D Patterns on Ground Plane -Cell

3D Pattern All Elements (650MHz)

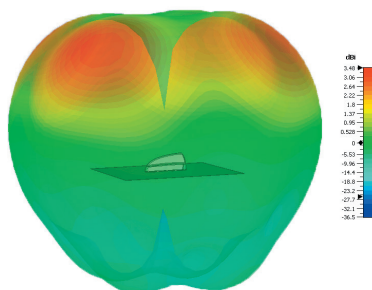

3D Pattern All Elements (750MHz)

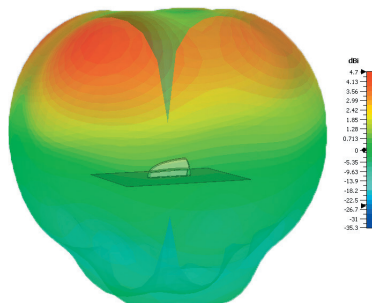

3D Pattern All Elements (850MHz)

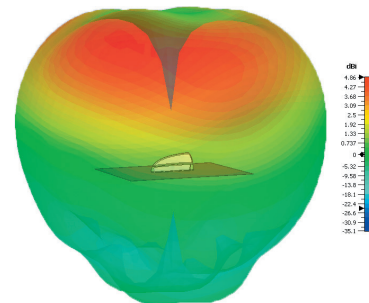

3D Pattern All Elements (1800MHz)

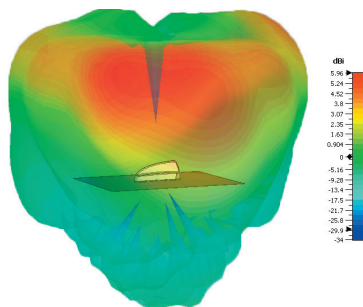

3D Pattern All Elements (2000MHz)

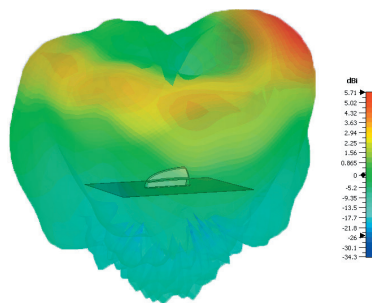

3D Pattern All Elements (2600MHz)

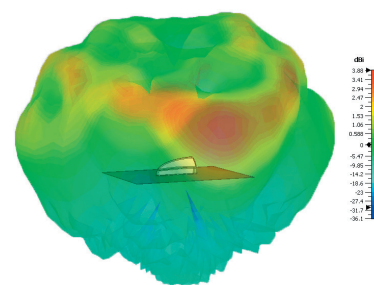

3D Pattern All Elements (3600MHz)

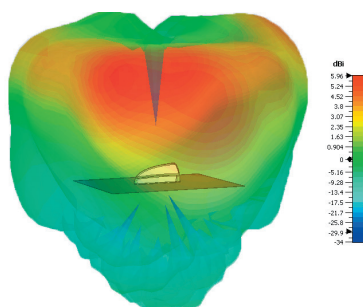

3D Pattern All Elements (5400MHz)

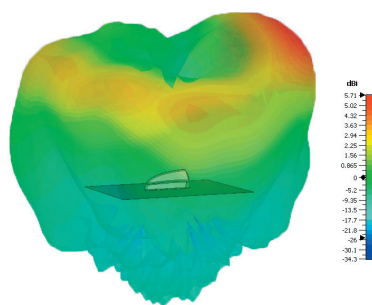

3D Patterns on Ground Plane -WIFI

3D Pattern All WiFi Elements (2450MHz)

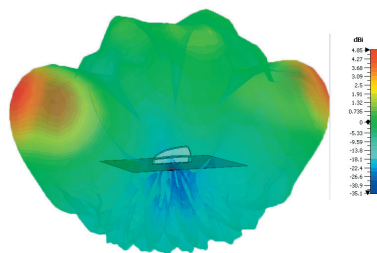

3D Pattern All WiFi Elements (5400MHz)

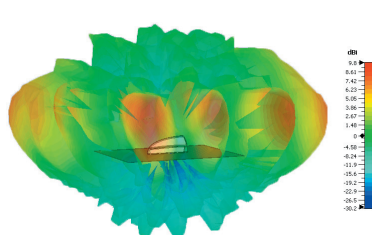

3D Pattern All WiFi Elements (7100MHz)

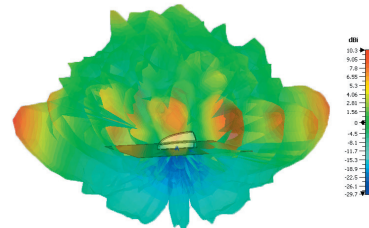

3D patterns all simulated in CST Microwave Studio with all elements of same type fed together excluding cable loss

4G/5G Sharkfin MiMo Antenna

GPSD-6-60[-VAR]

Electrical Data -in Free Space - Cell

3D Pattern All Elements (650MHz)

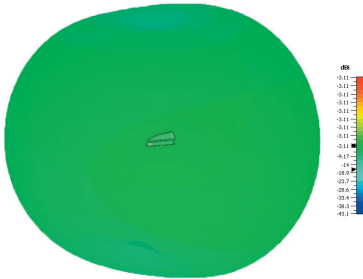

3D Pattern All Elements (750MHz)

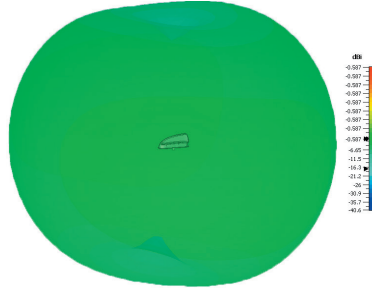

3D Pattern All Elements (850MHz)

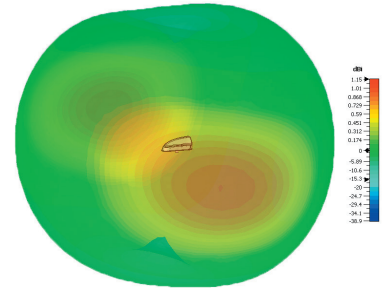

3D Pattern All Elements (1800MHz)

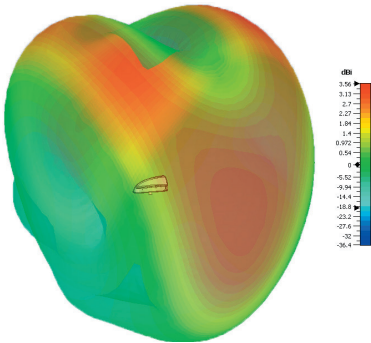

3D Pattern All Elements (2000MHz)

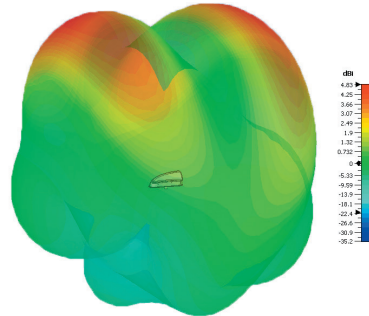

3D Pattern All Elements (2600MHz)

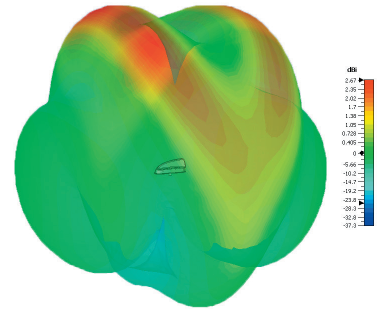

3D Pattern All Elements (3600MHz)

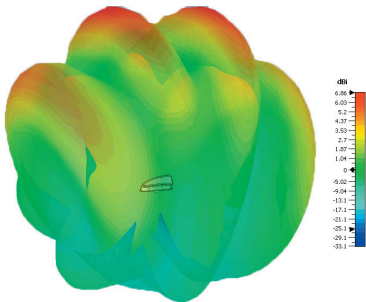

3D Pattern All Elements (5400MHz)

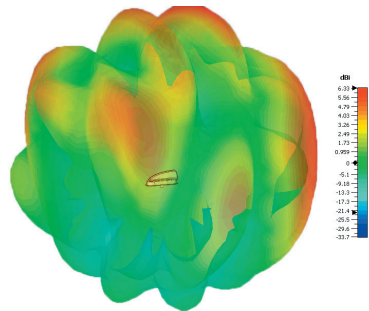

Electrical Data -in Free Space - WiFi

3D Pattern All WiFi Elements (2450MHz)

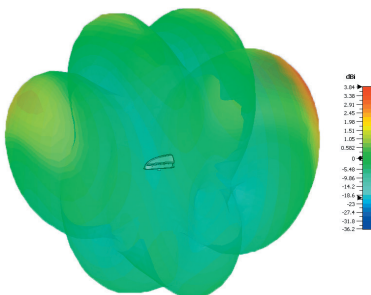

3D Pattern All WiFi Elements (5400MHz)

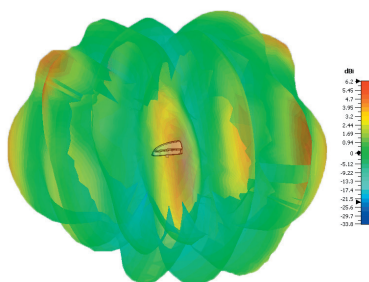

3D Pattern All WiFi Elements (7100MHz)

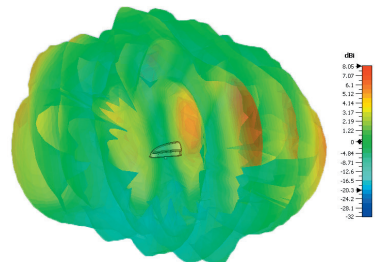

3D patterns all simulated in CST Microwave Studio with all elements of same type fed together excluding cable loss