

4x4 MiMo 4G/5G Dome Combination Antenna Range

MAKO 5G DOME



MAKO 5G DOME

- Low Profile 4x4 4G/5G MiMo
- Up to 6x6 MiMo Dual Band WiFi
- Optional GPS/GNSS Active Antenna 26dB LNA

The L[G]M[X]M4[X]-6-60[-24-58] range has been designed to provide 4x4 4G/5G MiMo performance from 617-960/1710-6000MHz in a robust low profile package. The flexible platform allows the main elements to be combined with a number of other functions including GPS/GNSS and up to 6x6 MiMo WiFi 2.4/5.0GHz or 4x4 WiFi 6E 2.4/4.9-7.2GHz.

The antenna is designed to be panel mounted and can be fitted on a conductive or non-conductive panel. Supplied with integrated flame retardant RG174 cables (Compliant to UN ECE R118 and EN45545-2) and a halogen free flame retardant radome the antenna is suitable for many environments and applications.

The LGM variants have an integrated GPS/GNSS module supporting GPS, Glonass, Galileo, QZSS and Compass with 26dB LNA gain. This GPS module features advanced filtering for LTE B13/14 designed to minimise potential in band interference.

The antenna is available with a black or white radome which meets IK10 for vandal resistance and IP69K for Ingress protection.

Technical Drawing

LGMHM4-6-60-24-58 Shown

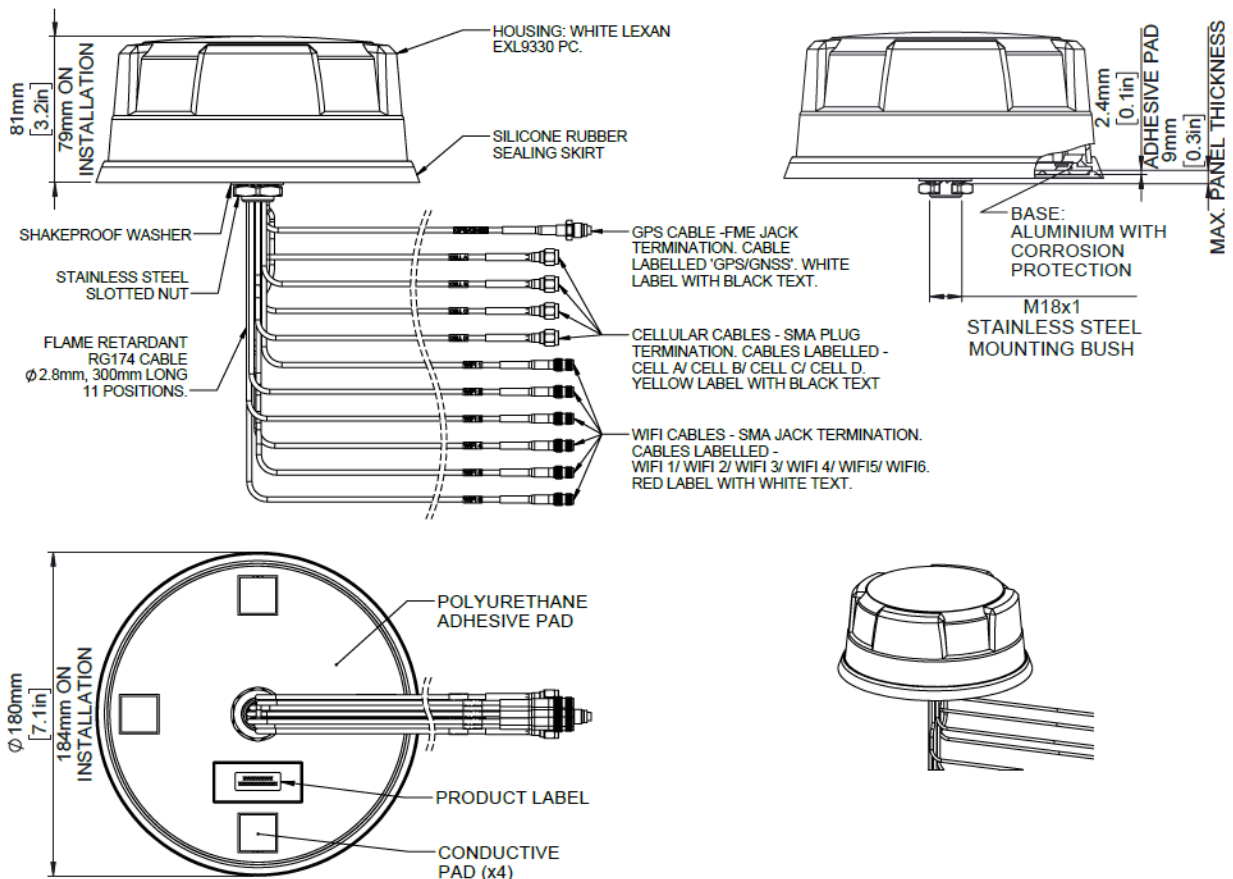

4x4 MiMo 4G/5G Dome Combination Antenna Range

MAKO 5G DOME

Part No.		LGMHM4-6-60-24-58	LGMHM4B-6-60-24-58	LGMQM4-6-60-24-58	LGMQM4B-6-60-24-58
Electrical Data					
Frequency Range (MHz)	4G/5G Elements	4x 617-960 / 1710-6000			
	WiFi Elements	6x 2.4/4.9-6GHz		4x 2.4/4.9-7.2GHz	
Peak Gain: Isotropic : (dBi)	4G/5G Elements	617-960MHz	4		
		1710-3800MHz	8		
	WiFi Elements	2.4 GHz	9		
		4.9-6 (7.2)GHz	9		
Typical Efficiency **	4G/5G Elements	617-960MHz	>50%		
		1710-3800MHz	>75%		
	WiFi Elements	4900-6000MHz	>85%		
				>70%	
Isolation ***	4G/5G Elements	>10dB			
	Wifi Elements	>12dB			
Correlation Co-efficient	4G/5G Elements	< 0.2			
	WiFi Elements	<0.1			
Nominal Impedance	50Ω				
GPS/GNSS Data					
Frequency Range (MHz)	1562-1612				
VSWR	<2.0:1 ± 4MHz				
Gain: LNA	26dB				
Out of band rejection	>40dB (@ > +/- 100MHz f)				
Typical Noise Figure	-2.7dB				
Notch Filter rejection @787MHz	23dBm				
Operating Voltage	3 - 5V DC				
Typical Current (mA)	15				
Mechanical Data					
Dimensions (mm)	Height	80 (3.1")			
	Diameter	180 (7.1")			
Operating Temp (°C)	-40°/ +80°C (-40° / +176°F)				
Colour	White	Black	White	Black	
Ingress Protection	IP69K				
Mounting Data					
Mounting type	Panel mount				
Max panel thickness (mm)	7 (0.27")				
Mounting hole (mm)	19 (3/4")				
Cable Data					
All Cables	Type	RG174 -FR (UN ECE R118 Compliant)			
	Diameter (mm)	2.8 (0.1")			
	Length (m)	0.3 (1')			
Terminations					
4G/5G	SMA (m)				
WiFi	SMA (f)				
GPS/GNSS	FME (f)				

4x4 MiMo 4G/5G Dome Combination Antenna Range

MAKO 5G DOME

Part No.

LGMTM4-6-60-24-58 LGMTM4B-6-60-24-58 LGMDM4-6-60-24-58 LGMDM4B-6-60-24-58

Electrical Data

Frequency Range (MHz)	4G/5G Elements	4x 617-960 / 1710-6000		
	WiFi Elements	3x 2.4/4.9-7.2GHz		2x 2.4/4.9-7.2GHz
Peak Gain: Isotropic : (dBi)	4G/5G Elements	617-960MHz	4	
		1710-3800MHz	8	
	WiFi Elements	2.4 GHz	9	
		4.9-7.2 GHz	9	
Typical Efficiency **	4G/5G Elements	617-960MHz	>50%	
		1710-3800MHz	>75%	
	WiFi Elements	4900-6000MHz	>85%	
		2.4 GHz	>70%	
Isolation ***	4G/5G Elements	>10dB		
	Wifi Elements	>12dB		
Correlation Co-efficient	4G/5G Elements	< 0.2		
	Wifi Elements	<0.1		
Nominal Impedance	50Ω			

GPS/GNSS Data

Frequency Range (MHz)	1562-1612		
VSWR	<2.0:1 ± 4MHz		-
Gain: LNA	26dB		
Out of band rejection	>40dB (@ > +/- 100MHz f)		
Typical Noise Figure	-2.7dB		
Notch Filter rejection @787MHz	23dBm		
Operating Voltage	3 - 5V DC		
Typical Current (mA)	15		

Mechanical Data

Dimensions (mm)	Height	80 (3.1")		
	Diameter	180 (7.1")		
Operating Temp	-40° / +80°C (-40° / +176°F)			
Colour	White	Black	White	Black
Ingress Protection	IP69K			

Mounting Data

Mounting type	Panel mount
Max panel thickness (mm)	7 (0.27")
Mounting hole (mm)	19 (3/4")

Cable Data

All Cables	Type	RG174 -FR (UN ECE R118 Compliant)
	Diameter (mm)	2.8 (0.1")
	Length (m)	0.3 (1')

Terminations

4G/5G	SMA (m)
WiFi	SMA (f)
GPS/GNSS	FME (f)

4x4 MiMo 4G/5G Dome Combination Antenna Range

MAKO 5G DOME

Part No.		LGMM4-6-60	LGMM4B-6-60	LPMM4-6-60	LPMM4B-6-60
Electrical Data					
Frequency Range (MHz)	4G/5G Elements	4x 617-960 / 1710-6000			
		617-960MHz	4		
Peak Gain: Isotropic : (dBi)†	4G/5G Elements	1710-3800MHz	8		
		4900-6000MHz	9		
Typical Efficiency **	4G/5G Elements	617-960MHz	>50%		
		1710-3800MHz	>75%		
		4900-6000MHz	>85%		
Isolation ***	4G/5G Elements	>10dB			
Correlation Co-efficient	4G/5G Elements	< 0.2			
Nominal Impedance					50Ω
GPS/GNSS Data					
Frequency Range (MHz)	1562-1612				-
VSWR	<2.0:1 ± 4MHz				-
Gain: LNA	26dB				-
Out of band rejection	>40dB (@ > +/- 100MHz f)				-
Typical Noise Figure	-2.7dB				-
Notch Filter rejection @787MHz	23dBm				-
Operating Voltage	3 - 5V DC				-
Typical Current (mA)	15				-
Mechanical Data					
Dimensions (mm)	Height	80 (3.1")			
	Diameter	180 (7.1")			
Operating Temp	-40° / +80°C (-40° / +176°F)				
Colour	White	Black	White	Black	
Ingress Protection	IP69K				
Mounting Data					
Mounting type	Panel mount				
Max panel thickness (mm)	7 (0.27")				
Mounting hole (mm)	19 (3/4")				
Cable Data					
All Cables	Type	RG174 -FR (UN ECE R118 Compliant)			
	Diameter (mm)	2.8 (0.1")			
	Length (m)	0.3 (1')			
Terminations					
4G/5G					SMA (m)
GPS/GNSS	FME (f)				-

**Typical efficiency shown for single element of relevant type simulated in CST Microwave Studio on 600x600mm (23.6"x23.6") ground plane excluding cable loss.

*** Isolation shown is worst case across all element pairings measured on 600x600mm (23.6"x23.6") ground plane with 0.5m (1'5") of Cable.

† Typical peak gain shown for single element of relevant type simulated in CST Microwave Studio on 600x600mm (23.6"x23.6") ground plane excluding cable loss.

4x4 MiMo 4G/5G Dome Combination Antenna Range

MAKO 5G DOME

Part No.		LPMM4-6-60	LPMDM4-6-60-24-58	LPMQM4-6-60-24-58
Electrical Data				
Frequency Range (MHz)	4G/5G Elements	4x 617-960 / 1710-6000		
	WiFi Elements	2x 2.4/4.9-7.2GHz		4x 2.4/4.9-7.2GHz
Peak Gain: Isotropic : (dBi)	617-960MHz	4		
	4G/5G Elements	1710-3800MHz	8	
		4900-6000MHz	9	
	WiFi Elements	2.4 GHz	9	
Typical Efficiency **		4.9-7.2 GHz	9	
		617-960MHz	>50%	
	4G/5G Elements	1710-3800MHz	>75%	
		4900-6000MHz	>85%	
Isolation ***	WiFi Elements	>70%		
	4G/5G Elements	>10dB		
Correlation Co-efficient	WiFi Elements	>12dB		
	4G/5G Elements	< 0.2		
Nominal Impedance	WiFi Elements	<0.1		
		50Ω		
Mechanical Data				
Dimensions (mm)	Height	80 (3.1")		
	Diameter	180 (7.1")		
Operating Temp	-40° / +80°C (-40° / +176°F)			
Colour	White	White	White	
Ingress Protection	IP69K			
Mounting Data				
Mounting type	Panel mount			
Max panel thickness (mm)	7 (0.27")			
Mounting hole (mm)	19 (3/4")			
Cable Data				
All Cables	Type	RG174 -FR (UN ECE R118 Compliant)		
	Diameter (mm)	2.8 (0.1")		
	Length (m)	0.3 (1')		
Terminations				
4G/5G	SMA (m)			
WiFi	SMA (f)			

Electrical Data - Cell

Typical VSWR - 4G/5G Elements*

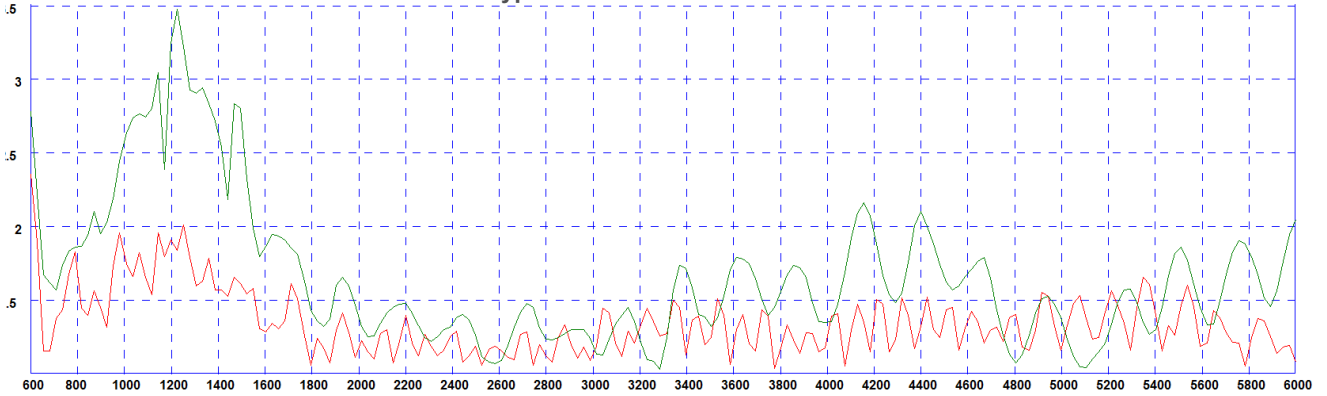

* Green Trace measured with 0.5m (1.5') of RG174 cable Red Trace measured with 5m(17') of CS32 Cable both on a 600x600mm (2'x2') groundplane

Typical Isolation - 4G/5G Elements*

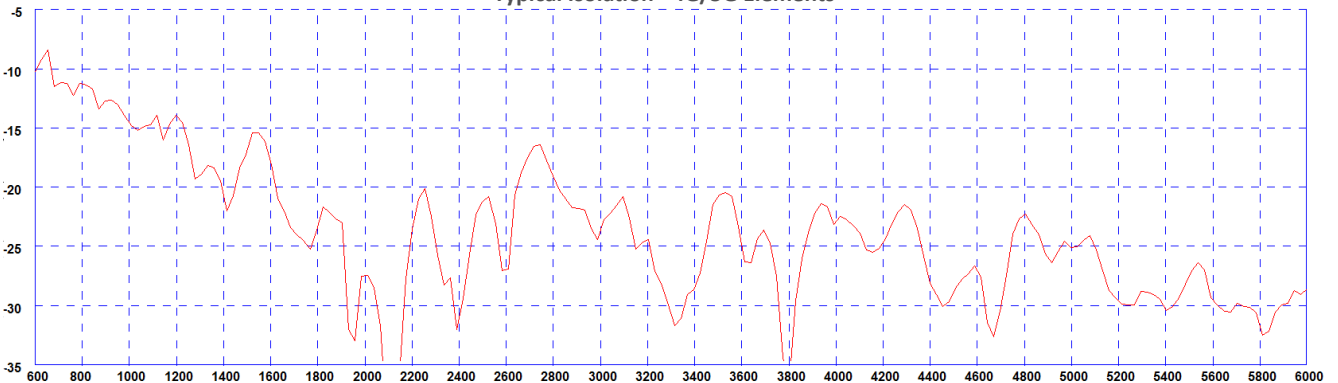

* measured with 0.5m (1.5') of RG174 cable on a 600x600mm (2'x2') groundplane

Typical VSWR - WiFi Elements*

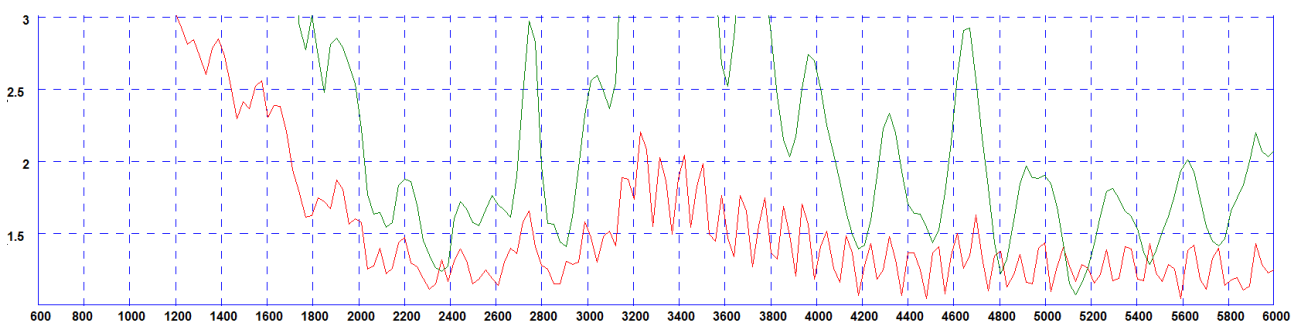

* Green Trace measured with 0.5m (1.5') of RG174 cable Red Trace measured with 5m(17') of CS32 Cable both on a 600x600mm (2'x2') groundplane

4x4 MiMo 4G/5G Dome Combination Antenna Range

MAKO 5G DOME

Typical Efficiency- 4G/5G Elements*

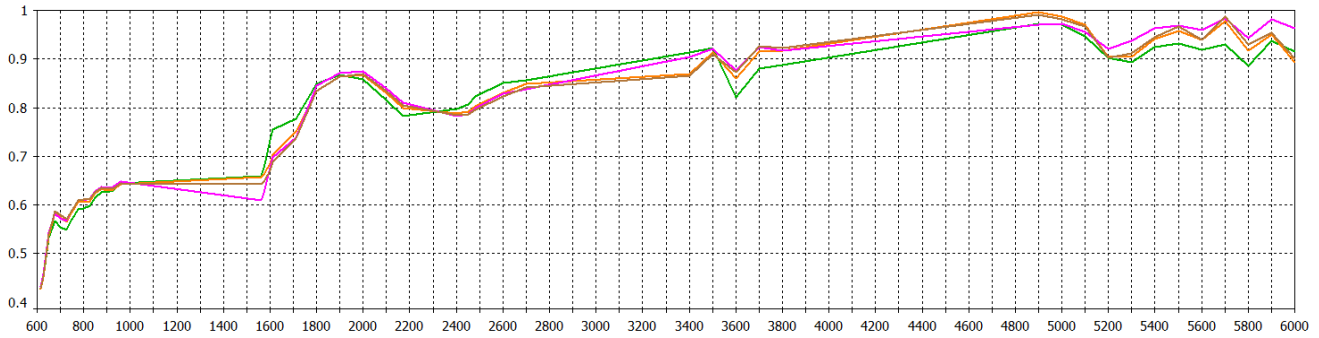

* Efficiency modelled with CST Microwave Studio with antenna mounted on 600x600mm (2'x2') ground plane and ignores cable losses

Typical Peak Gain - 4G/5G Elements*

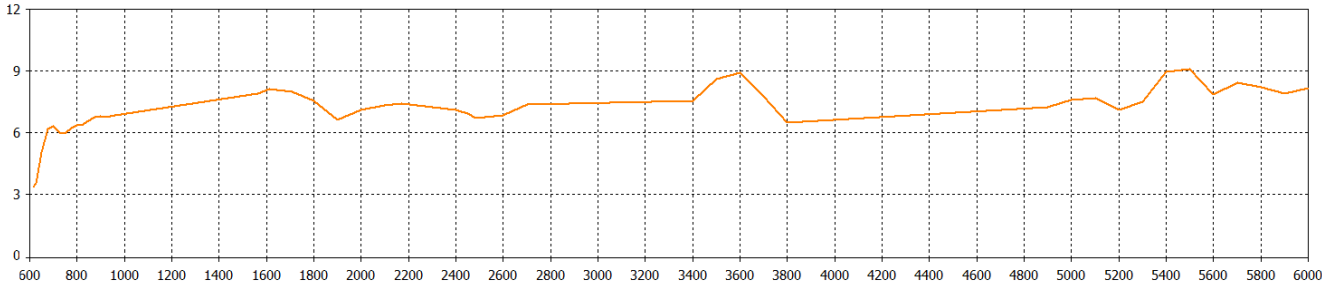

*Swept peak gain modelled with one element fed in CST Microwave Studio on a 600x600mm (2'x2') ground plane excluding cable loss

Typical Efficiency - WiFi Elements*



* Efficiency modelled for 4x4 MiMo Wifi version with CST Microwave Studio with antenna mounted on 600x600mm (2'x2') ground plane and ignores cable

Typical Swept Peak Gain - WiFi Elements*

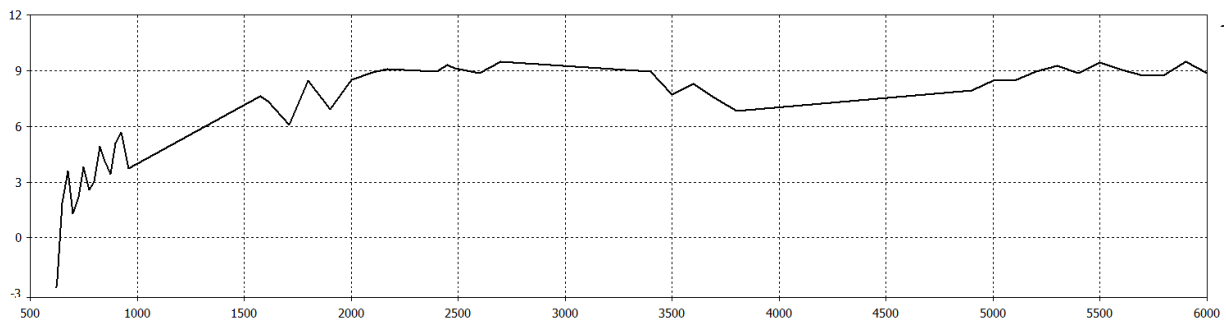

*Swept peak gain modelled with one element fed in CST Microwave Studio on a 600x600mm (2'x2') ground plane excluding cable loss

4x4 MiMo 4G/5G Dome Combination Antenna Range MAKO 5G DOME

4G/5G Pattern Data

Typical 3D Pattern LTE Elements
Side 617MHz

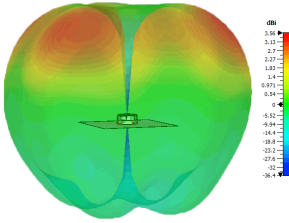

Typical 3D Pattern - LTE Elements
Top 617MHz

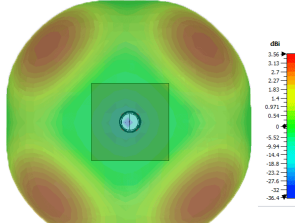

Typical 3D Pattern LTE Elements
Side 700MHz

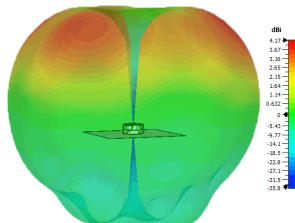

Typical 3D Pattern LTE Elements
Top 700MHz

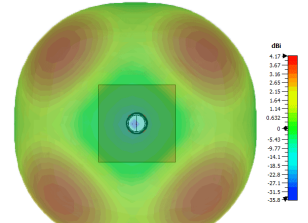

Typical 3D Pattern LTE Elements
Side 800MHz

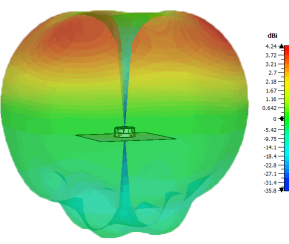

Typical 3D Pattern - LTE Elements
Top 800MHz

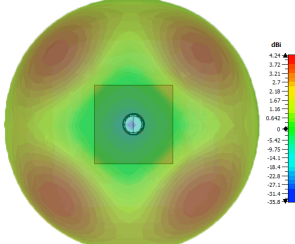

Typical 3D Pattern LTE Elements
Side 1800MHz

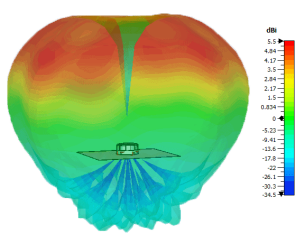

Typical 3D Pattern LTE Elements
Top 1800MHz

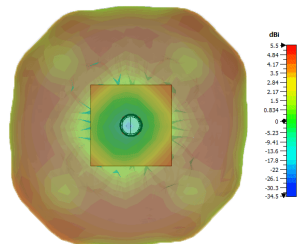

Typical 3D Pattern LTE Elements
Side 2100MHz

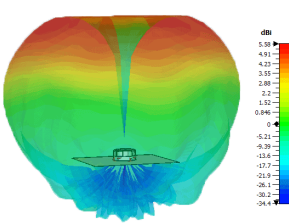

Typical 3D Pattern - LTE Elements
Top 2100MHz

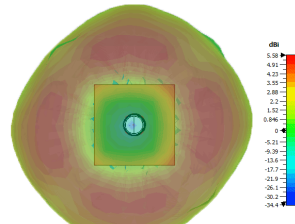

Typical 3D Pattern LTE Elements
Side 2600MHz

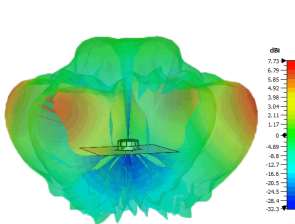

Typical 3D Pattern LTE Elements
Top 2600MHz

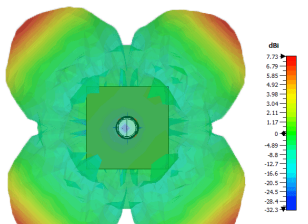

Typical 3D Pattern LTE Elements
Side 3600MHz

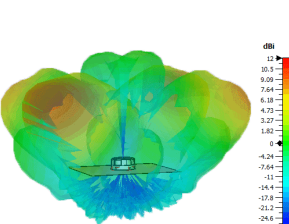

Typical 3D Pattern - LTE Elements
Top 3600MHz

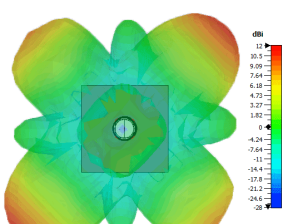

Typical 3D Pattern LTE Elements
Side 5400MHz

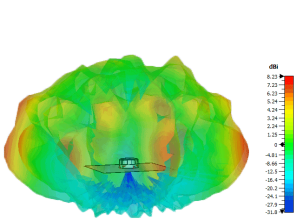

Typical 3D Pattern LTE Elements
Top 5400MHz

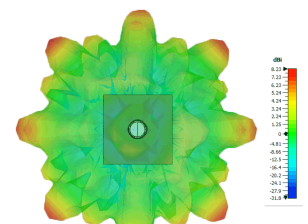

*Patterns are LGMQM4-6-60-24-58 modelled in CST Microwave Studio on a 600x600mm(2'x2') ground plane with all elements of each type fed.

WiFi Pattern Data

Typical 3D Pattern WiFi Elements
Side 2450MHz

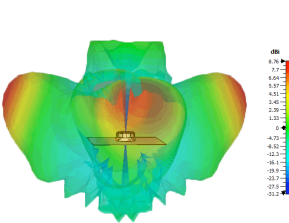

Typical 3D Pattern - WiFi Elements
Top 2450MHz

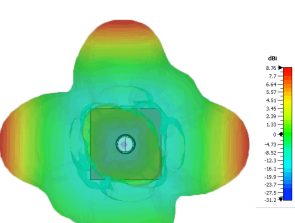

Typical 3D Pattern WiFi Elements
Side 5400MHz

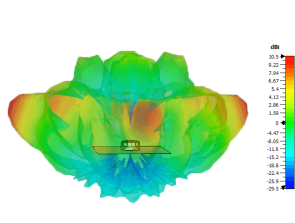

Typical 3D Pattern WiFi Elements
Top 5400MHz

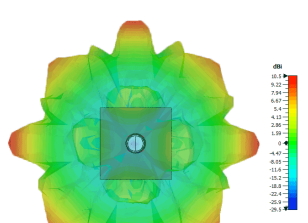

*Patterns are LGMQM4-6-60-24-58 modelled in CST Microwave Studio on a 600x600mm(2'x2') ground plane with all elements of each type fed.