

1 2 3 4 5 6 7 8 9 10 11 12 13 14

A

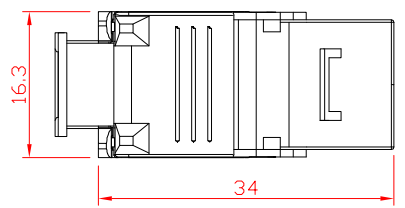
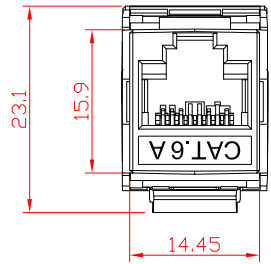
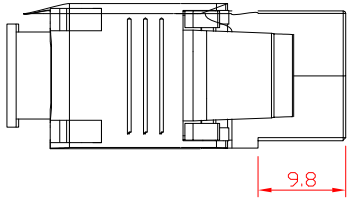

B

C



Art.-Nr. Item No.	Farbe colour
90687	grün green
90688	blau blue
90689	rot red
90690	orange orange
90691	gelb yellow
90692	schwarz black
90693	hellgrau light grey
90867	weiß white

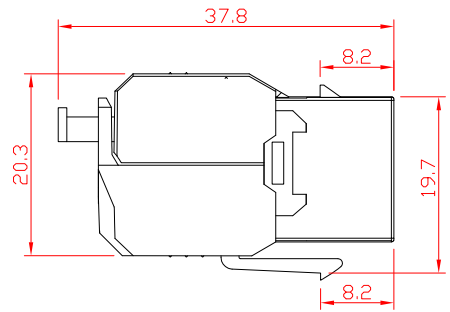
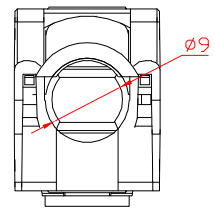

D

E

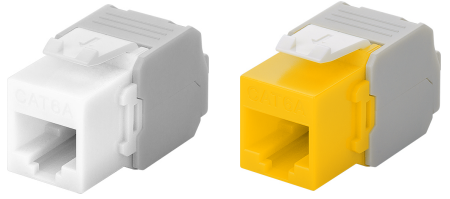

F

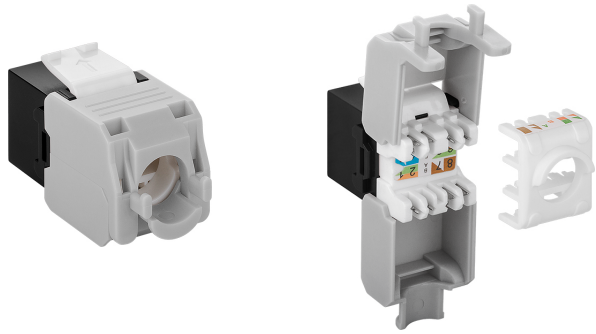

Keystone Modul RJ45

- Anschlüsse sind TIA 568A/B farbkodiert
- PoE nach IEEE 802.3at
- nicht geeignet für Litzen Draht
- Betriebstemperatur: -20°C ~ +85°C
- Massivkabel: 0,48 - 0,65 mm, AWG 22 - 26
- Außendurchmesser Kabel: 5,0 mm - 9,0 mm
- Anschlüsse: RJ45-Buchse (8P8C), Klemmleiste für LSA Montage PC
- Material Gehäuse: PC
- Dauerhaftigkeit: RJ45: 750x min. Steckverbindung: LSA: 200x min.
- Material Kontakte: Phosphorbronze
- Nennspannung: 125 V ~
- Nennstrom: 1,5 A
- Kontaktwiderstand: 10 MΩ max.
- Isolationswiderstand: 1000 MΩ min. @ 500 V =
- Spannungsfestigkeit: 750 V ~ RMS, 60 Hz, 1 min
- Konformität: REACH, RoHS

KeyStone RJ45 module

- connectors have TIA 568A/B colour code
- PoE per IEEE 802.3at
- not suitable for stranded wire
- operation temperature: -20°C ~ +85°C
- Solid cables: 0.48 - 0.65 mm, AWG 22 - 26
- Outer diameter cable: 5.0 mm - 9.0 mm
- Connectors: RJ45 socket (8P8C), terminal strip for LSA mounting PC
- Material housing: PC
- Mating durability: RJ45: 750x min. LSA: 200x min.
- Material contacts: phosphor bronze
- Rated voltage: 125 V ~
- Rated current: 1.5 A
- Contact resistance: 10 MΩ max.
- Insulation resistance: 1000 MΩ min. @ 500 V =
- Dielectric strength: 750 V ~ RMS, 60 Hz, 1 min
- Conformity: REACH, RoHS

H

I

Änderungen		Datum	Name	Bezeichnung	Blatt
Datum	Name	gez.:	10.02.2021	NET Keystone CAT 6a UTP LSA xxx	1/1
		gepr.:	10.02.2021		
		Norm:		Zeichnungs-Nr.:	von
Änderungen vorbehalten / Subject to change				90687, 90688, 90689, 90690, 90691, 90692, 90693, 90867	



1 2 3 4 5 6 7 8 9 10 11 12 13 14

J

J