

ANTENNAS | PUCK-7

4-IN-1 TRANSPORTATION & IOT/M2M ANTENNA

698 - 3800 MHz; 2X2 LTE (MIMO), 6 dBi; 2X2 Wi-Fi (MIMO), 7.5 dBi

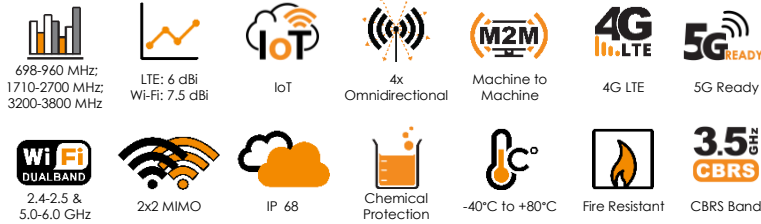

- **4-in-1 high performance multi frequency**
- **2G/3G/4G/LTE antenna (5G Ready)**
- **LTE (2 x MiMo), Dualband Wi-Fi (2 x MiMo)**
- **Wideband – covers wide frequency band, incl. the CBRS band**
- **Ground plane independent**
- **Robust, vandal resistant and water proof (IP68) antenna**
- **Ideal for transportation, marine and IoT/M2M use**
- **Ultra-versatile mounting options for easy installation**



Product Overview

Poynting's new PUCK range offers a small profile antenna for use in the IoT/M2M, Smart Meter, Smart Utilities, Transportation, Marine and the Agricultural/Farming markets. The PUCK-7 consists of a 4-in-1 antenna system within a single housing, featuring 2x2 MIMO LTE and 2x2 MIMO Wi-Fi (Dual-band 2.4GHz & 5GHz) The 2x Cellular MIMO antennas (for 2G/3G/4G) cover the 698MHz to 3800MHz band, this includes the most popular international LTE bands. The antenna provides two separate dual-band Wi-Fi antennas offering concurrent 2.4GHz and 5GHz bands, capable of 802.11n and 802.11ac/ax with 2x2 MIMO. The PUCK exceeds the performance of many competitors due to the attention to design of this high-performance antenna. The radiation patterns of all radiating elements provide an excellent balance between omnidirectionality, pattern diversity and good radiation abilities at the desired elevation, which is often overlooked in such a small size antenna. Despite its small size, this antenna provides excellent performance especially at the higher frequency bands, where performance is critical for LTE throughput and connection stability. This antenna is designed so that both the LTE ports are connected to the router/device to ensure the best performance. Please see other derivatives of the PUCK range that are more suitable for a SISO application.

Features

- Small & Low-Profile (100mm x h 36mm)
- Careful mechanical design provides ruggedness, corrosion, water, dust resistance (IP68)
- Fire Resistant
- UV Stable Enclosure
- Ground plane independent – performs consistently with and without a ground plane
- 5G Ready; includes 3.2GHz to 3.8GHz CBRS Band
- Easy installation; multi implementation options (as standard)
 - Spigot Mount
 - Magnetic Mount
 - Adhesive Tape Mount
 - Bracket Mount

Application Areas

- Smart Utilities: Smart Power, Gas & Water Metering
- Smart Buildings: Climate control, access control, security, irrigation
- Digital Signage
- Warehouses & Logistic systems
- Industrial factory automation, robotic machinery and other M2M systems
- Transport (Busses, Utility & Public Safety)
- Mining Vehicles & Machinery communications, telemetry and automation (M2M & IoT)
- Agricultural machinery
- Marine: small boats, yachts near to coastlines or inner waters



Frequency Bands – Cellular & Wi-Fi

The PUCK-7 is suitable for the following Cellular frequency bands | 698-960 MHz | 1710-3800 MHz | and the following Wi-Fi frequency bands | 2400-2500 MHz | | 5000-6000 MHz |

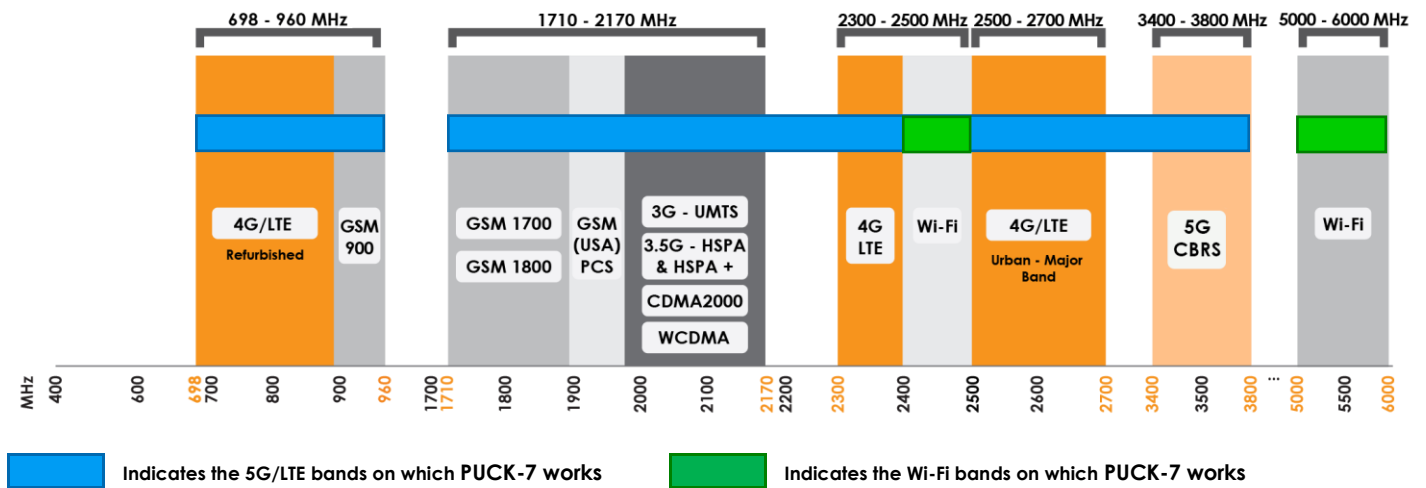

Antenna Overview

	LTE	Wi-Fi DUAL BAND
Ports	1 & 2	3 & 4
SISO / MIMO	2x2 MIMO	2x2 MIMO
Frequency Bands	698 MHz - 3800 MHz	2.4 - 2.5 & 5-6 GHz,
Peak Gain	6 dBi	7.5 dBi
Coax Cable Type	RTK-031	RTK-031
Coax Cable Length	2m	2m
Connector Type	SMA Male	SMA Male (RP-SMA Adapter included)

**The coax cable & connector are factory mounted to the antenna*

Electrical Specifications - Cellular

Frequency bands:	698-960 MHz 1710-2700 MHz 3200-3800 MHz
Gain (max) Port 1 & 2:	-1 dBi @ 698-960 MHz 6 dBi @ 1710-2700 MHz 6 dBi @ 3200-3800 MHz
VSWR Port 1 & 2:	≤2.5:1 over 85% of the band
Feed power handling:	10 W
Input impedance:	50 Ohm (nominal)
Polarisation:	Linear Vertical
Coax cable loss:	0.56 dB/m @ 900 MHz 0.65 dB/m @ 1500MHz 0.72 dB/m @ 1800MHz 1.2 dB/m @ 3000 MHz
DC Short:	Yes

Wi-Fi Electrical Specifications

Frequency:	2400-2500 MHz 5000-6000 MHz
Gain (Max) Port 1 & 2:	5 dBi @ 2400-2500 MHz 7.5 dBi @ 5000-6000 MHz
VSWR Port 1 & 2:	≤2.5:1 over 95% of the band
Feed power handling:	10 W
Nominal input impedance:	50 Ohm (nominal)
Polarisation:	Linear Vertical
Coax cable loss:	0.88 dB/m @ 2400 MHz 1.65 dB/m @ 5800 MHz
Path to Ground:	Yes

Product Box Contents

Antenna:	A-PUCK-0007-V1-01
Mounting bracket:	Ø20 Threaded Spigots (Up to 60mm clamping thickness), Adhesive Surface Mounting & Magnetic Mount
Adapters:	2x RPSMA(m) To SMA (f)

Ordering Information

Commercial name:	PUCK-7
Order product code:	A-PUCK-0007-V1-01
EAN number:	6009710920497

Mechanical Specifications

Product dimensions	Ø99.3 mm x 36 mm
Packaged dimensions:	150 mm x 150mm x 120mm
Weight:	0.476kg
Packaged weight:	0.607kg
Radome material:	PC+ABS (Halogen free)
Radome colour:	Black
Mounting Type:	Ø20 Threaded Spigot, Pole, Wall, Surface and Magnetic mount

Environmental Specifications, Certification & Approvals

Wind Survival:	≤220 km/h
Temperature Range (Operating):	-40°C to +80°C
Environmental Conditions:	Outdoor/Indoor
Water ingress protection ratio/standard:	IP 68 – 30 minutes up to 1.5m
Salt Spray:	MIL-STD 810F/ASTM B117
Operating Relative Humidity:	Up to 98%
Storage Humidity:	5% to 95% - non-condensing
Storage Temperature:	-40°C to +80°C
Enclosure Flammability Rating:	UL 94-HB
Impact resistance:	IK 10
Product Safety & Environmental:	Complies with CE and RoHS standards



Technical Drawings

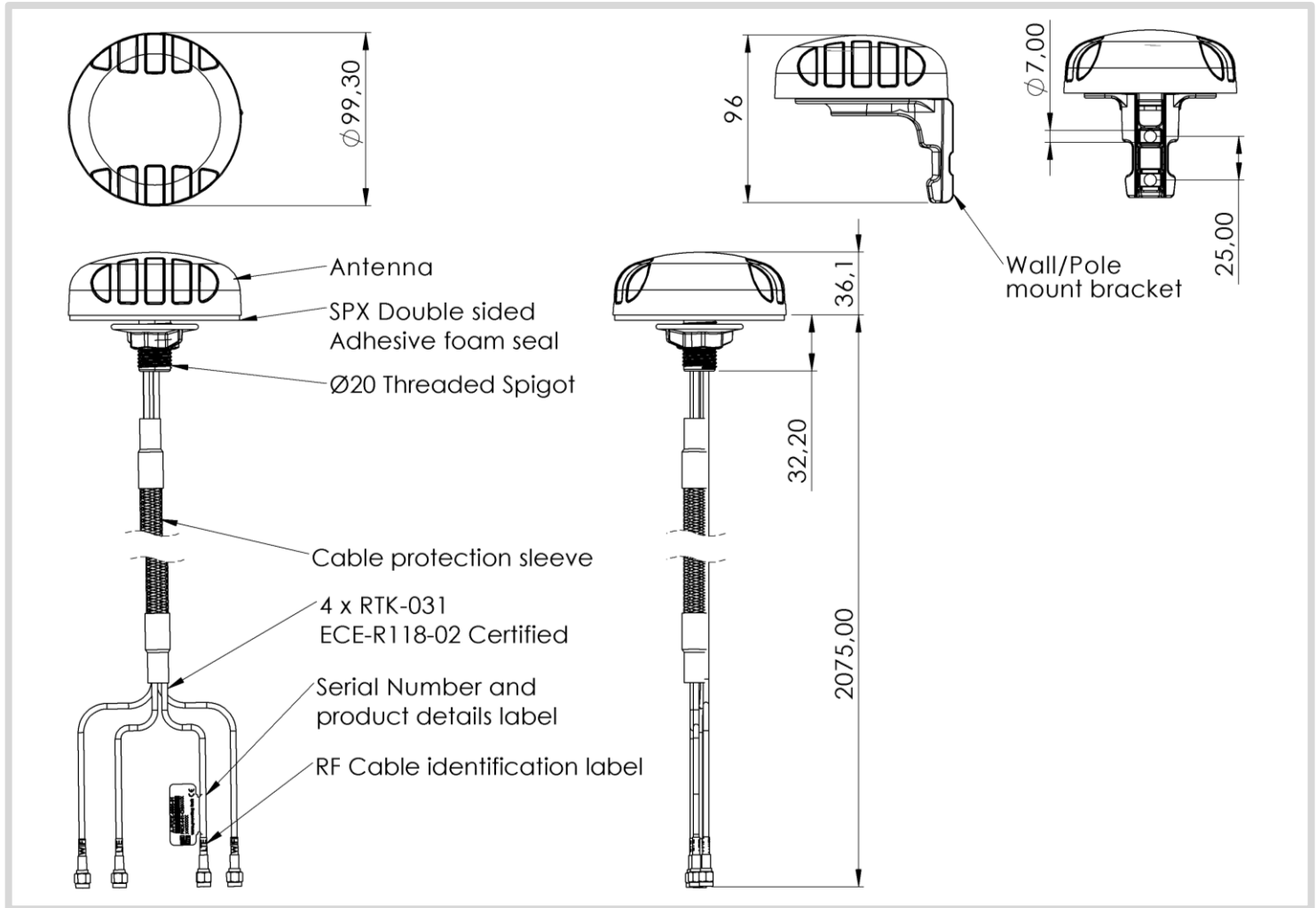

Antenna Performance Plots

VSWR: Cellular Antenna

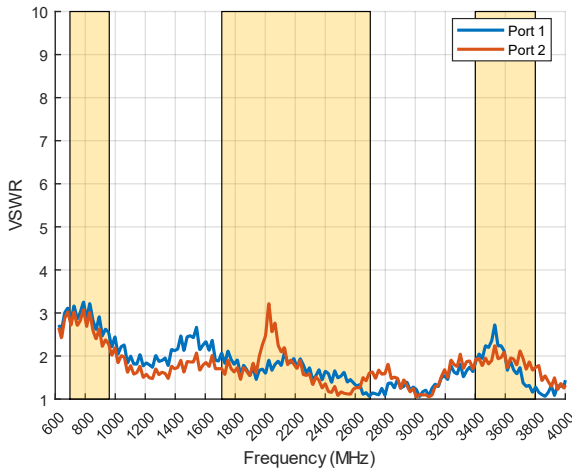

Voltage Standing Wave Ratio (VSWR)*

VSWR is a measure of how efficiently radio-frequency power is transmitted from a power source, through a transmission line, into a load. In an ideal system, 100% of the energy is transmitted which corresponds to a VSWR of 1:1.

The PUCK-7 delivers superior performance across all bands with a VSWR of $\leq 2.5:1$ over 85% of the band

*Measured with 2m low loss cable

*Measured with 50Ω load terminated to unused port

Gain: Cellular Antenna

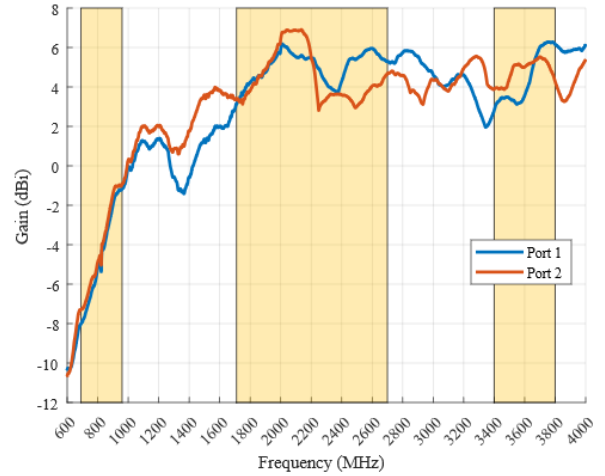

Gain in dBi

6 dBi is the peak gain across all bands from 698-960, 1710-2700 & 3400-3800 MHz

Peak Gain @ different bands: -1 dBi @698-960MHz
 Peak Gain @ different bands: 6 dBi @ 1710-2700MHz
 Peak Gain @ different bands: 6 dBi @3400-3800MHz

VSWR: Wi-Fi Antenna

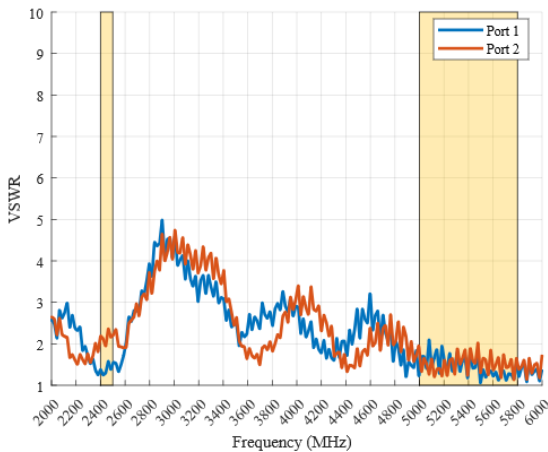

Voltage Standing Wave Ratio (VSWR)*

VSWR is a measure of how efficiently radio-frequency power is transmitted from a power source, through a transmission line, into a load. In an ideal system, 100% of the energy is transmitted which corresponds to a VSWR of 1:1.

The PUCK-7 delivers superior performance across all bands with a VSWR of $\leq 2.5:1$ over 95% of the band

*Measured with 2m low loss cable

Gain: Wi-Fi Antenna

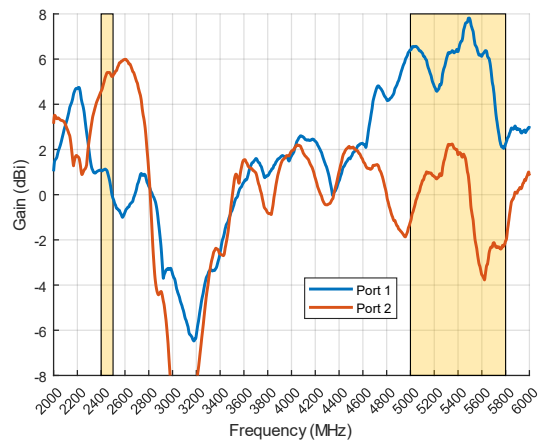

Gain in dBi

7.5 dBi is the peak gain across all bands from 2400-2500 & 5000 – 5800 MHz

Peak Gain @ different bands: 5 dBi @2400-2500MHz
 Peak Gain @ different bands: 7.5 dBi @ 5000-5800MHz

Radiation Patterns – Cellular

Azimuth (Top View): 698–960 MHz

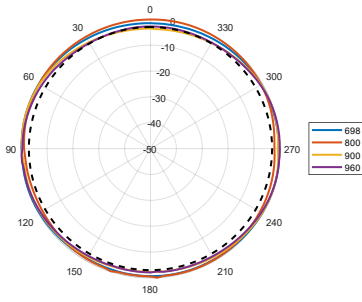

Azimuth (Top View): 1710–2100 MHz

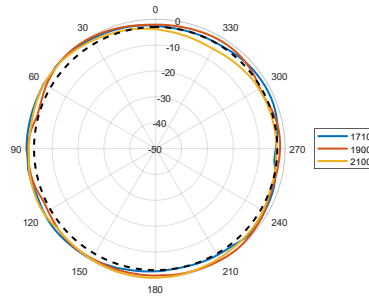

Azimuth (Top View): 2300–2700 MHz

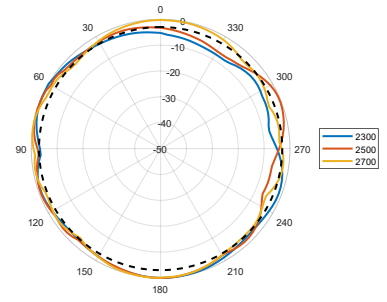

Azimuth (Top View): 3400–3800 MHz

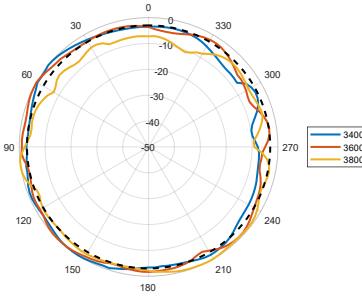

Elevation1 (Side View): 698–960 MHz

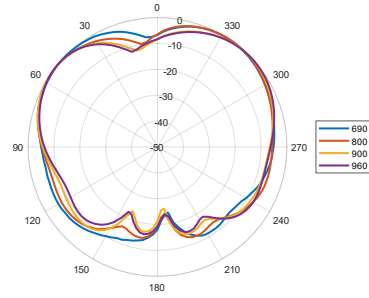

Elevation1 (Side View): 1710–2100 MHz

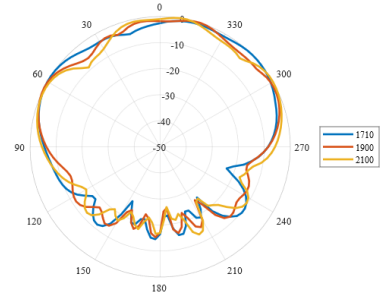

Elevation1 (Side View): 2300–2700 MHz

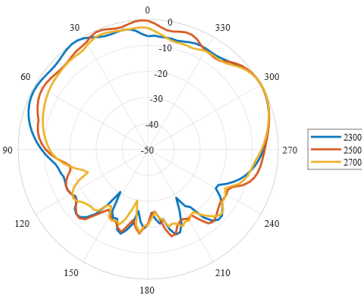

Elevation1 (Side View): 3400–3800 MHz

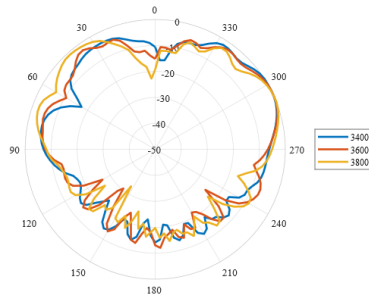

Elevation2 (Side View): 698–960 MHz

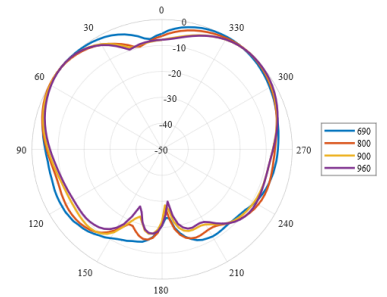

Elevation2 (Side View): 1710–2100 MHz

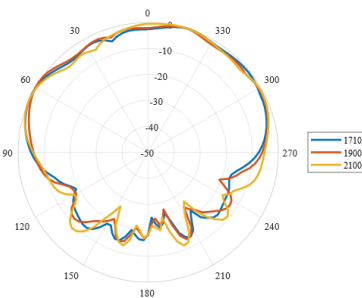

Elevation2 (Side View): 2300–2700 MHz

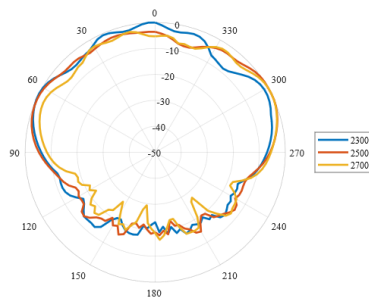

Elevation2 (Side View): 3400–3800 MHz

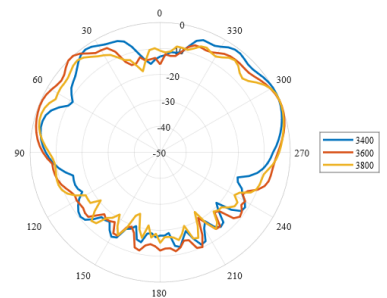

Radiation Patterns – Wi-Fi

Azimuth (Top View): 2400–2500 MHz

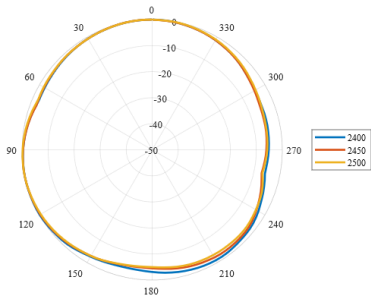

Azimuth (Top View): 5000–5400 MHz

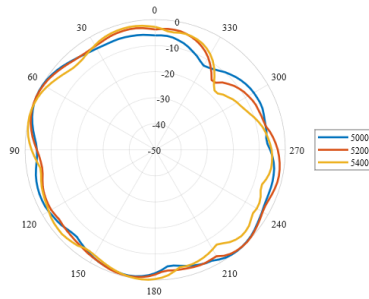

Azimuth (Top View): 5600–5800 MHz

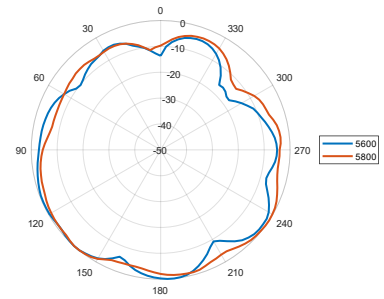

Elevation1 (Side View): 2400–2500 MHz

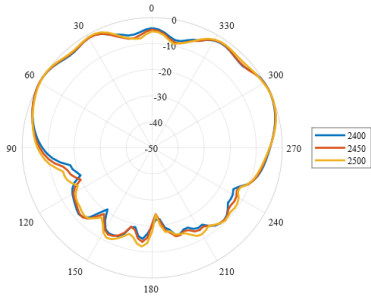

Elevation1 (Side View): 5000–5400 MHz

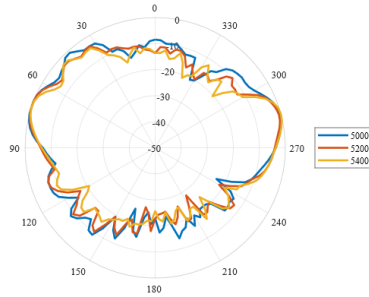

Elevation (Side View): 5600–5800 MHz

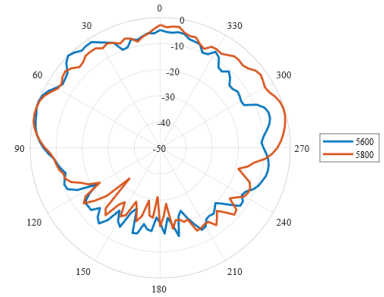

Elevation2 (Side View): 2400–2500 MHz

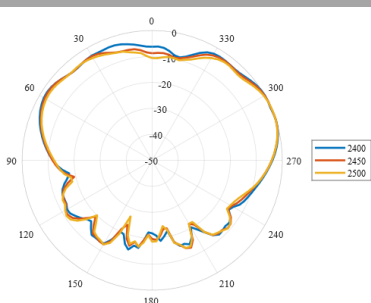

Elevation2 (Side View): 5000–5400 MHz

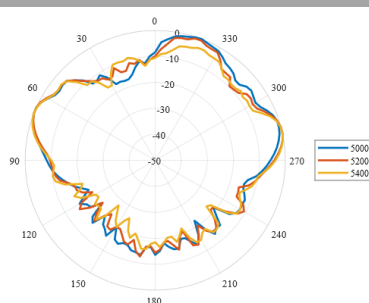

Elevation2 (Side View): 5600–5800 MHz

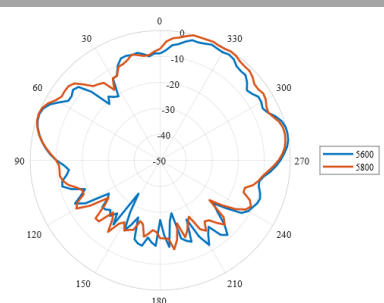

Mounting Options

Many Mounting Possibilities – included as standard

Poynting's new PUCK antenna range provides easy installation with the multiple mounting options. This includes as standard:

- Spigot Mount - two different lengths included (40mm & 80mm)
- Vertical Pole mount (inner & outer mounting for smaller and larger poles)
- Horizontal Pole Mount (e.g. marine rails)
- Magnetic Mount
- Surface Mount (Double Sided Tape)
- Wall Mount

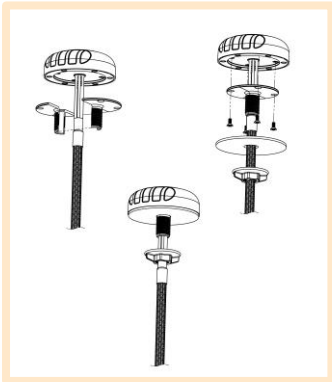

Spigot Mount

Removable 40mm & 80mm threaded spigot (included)

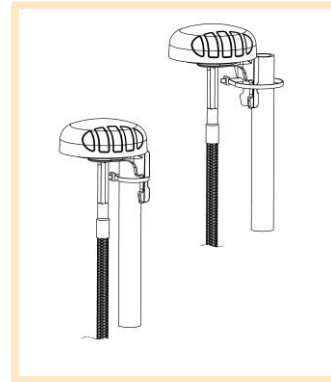

Vertical Pole Mount

Pole/Wall Mounting bracket (included)

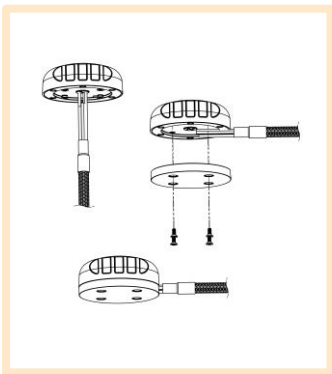

Magnetic Mount

Magnetic Base (included)
For temporary and low mobility installations.

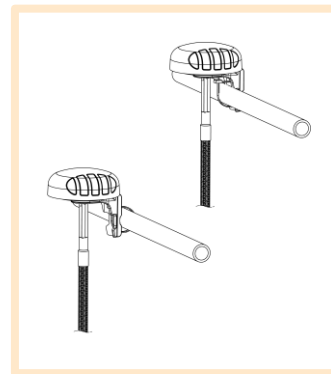

Horizontal Pole Mount

Pole/Wall Mounting bracket (included)

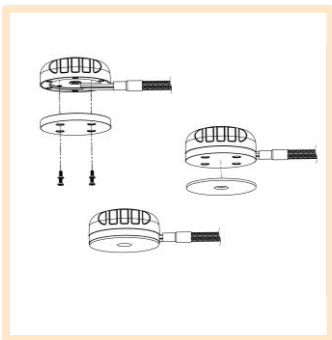

Surface Mount

Adhesive Surface Mounting (included) or can also be directly secured with longer M4 bolts (not included) to the female threaded inserts located in the antenna base



Wall Mount

Pole/Wall Mounting bracket (included)

Additional Accessories

See accessories technical specifications on www.poynting.tech

Contact Poynting

Poynting Antennas (Pty) Ltd - Head Office

Unit 4, N1 Industrial Park
Landmarks Avenue,
Samrand, 0157
South Africa

Phone: +27 (0) 12 657 0050

E-mail: sales@poynting.co.za

Poynting Europe

Regus Business Center Neue Messe Riem
Kronstadter Straße 4
81677 München
Germany

Phone: +49 89 208026538

E-mail: sales-europe@poynting.tech