

# 4X4 MiMo 4G/5G

## Transit Antenna

TRNM[X]4-6-60-[X]



### Low Profile Transit Antenna

4x4 MiMo 617-960/1427-6000MHz

Up to 4x4 MiMo WiFi 6e (Optional)

GPS/GNSS 26dB LNA (Optional)

Meets Railway Standards EN50155, EN45545-2 and EN50124-1

The TRNM[X]4-6-60-[X] MiMo antenna series is designed for use on trains, trams and buses underground or over ground. Incorporating four wide band elements covering the frequency range 617MHz to 6000MHz, the TRNM[X]4-6-60-[X] series is versatile and future proof.

The TRNM[X]4-6-60-[X] series covers global 4G/5G frequencies with 4x4 MiMo, optional up to 4x4 MiMo Wifi 6e and optional GPS/GNSS.

Housed in a high impact, flame retardant Ultem housing, the antenna is fully weatherproof ensuring a long service life with no compromise in performance.

The TRNM[X]4-6-60-[X] antenna meets stringent industry standards including EN50155, EN45545-2 (HL 1-3), EN50124-1\* and is ingress protected to IP69k when correctly installed.

\*Whole assembly compliant to 27.5 KV AC Insulation Test. Cell/LTE elements tested to 40KA AC Short Circuit Test.

### Technical Drawing

TRNMG4-6-60-Q Shown

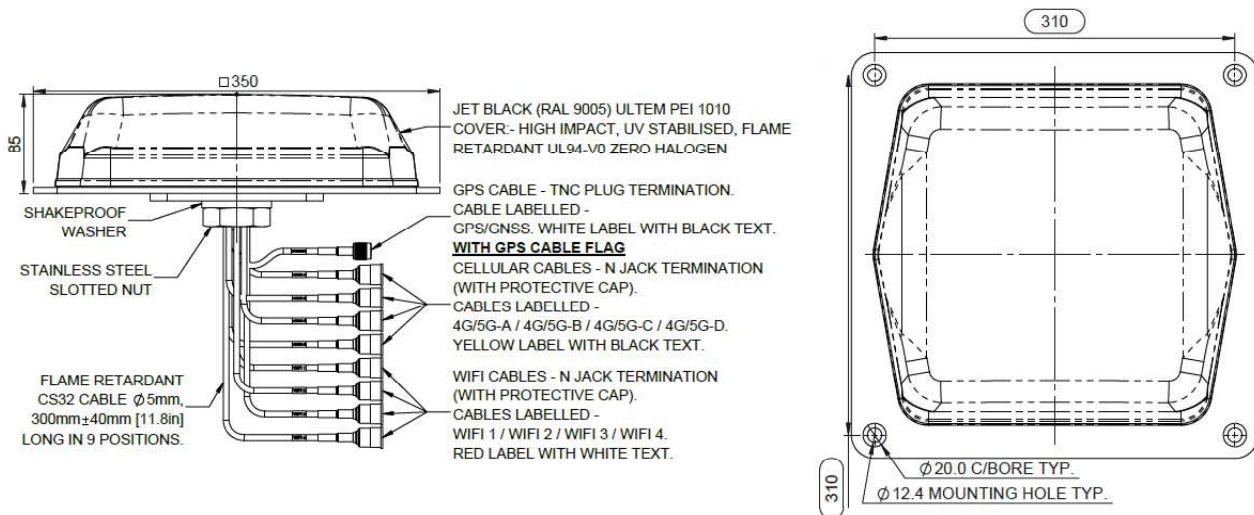

# 4X4 MiMo 4G/5G

## Transit Antenna

TRNM[X]4-6-60-[X]

PANORAMA ANTENNAS

### Product Data

Part No.	TRNMG4-6-60-Q	TRNMG4-6-60-T	TRNMG4-6-60-D	TRNMG4-6-60	TRNM4-6-60
<b>Electrical Data</b>					
Frequency Range (MHz)	Cell /LTE	4x 617-960 / 1427-6000			
	WiFi	4x 2396-7125	3x 2396-7125	2x 2396-7125	-
	GPS/GNSS	1x 1562-1612			
Typical VSWR*	Cell Elements	< 2:1			
	WiFi Elements	< 2:1		-	-
Correlation Co-efficient	Cell Elements	<0.1			
	Wifi Elements	<0.1		-	-
Pattern	Omni-directional				
Impedance	50Ω				
Max Input Power (W)	60				
<b>GPS/GNSS Data</b>					
Frequency Range (MHz)	1559-1612				-
Impedance	50Ω				-
LNA Gain	26dB				-
Voltage / Current	3-5v 15ma Typical				-
Polarisation	Right Hand Circular				-
<b>Mechanical Data</b>					
Dimensions (mm)	Height	85 (3.34")			
	Width	350 (13.78")			
	Length	350 (13.78")			
<b>Environmental Specification</b>					
Operating Temp (°C)	-40° / +85°C ( -40° / +185°F )				
Radome Material	Ultem 1010				
Radome Flame Retardance Rating	V0 (UL 94)				
Base Material	Cast Aluminium (corrosion protected & powder coated)				
<b>Rail Industry Approvals</b>					
Flammability	EN45545-2:2020 - HL3 External				
Environmental	EN50155:2021 -Low temperature, dry heat, salt mist, damp heat cyclic, shock, random vibration, long life random vibration				
EMC/EMI	EN 50121-3-2:2016 A1: 2019 - EMC / EMI				
Insulation / Short Circuit	EN 50124-1:2017 - Insulation Test - (27.5KV AC 50Hz 1 min)   EN50388:2012 / EN50122-1:2022 - (40kA 50Hz AC 100ms ) - Cell elements only				
Ingress Protection / Vandal Protection	ISO 20653: 2013 - IP69K   EN 62262:2002 - IK07				
<b>Mounting Data</b>					
Fixing	4 × mounting holes to suit M12 bolts 1x M33 central mounting bush				
<b>Termination Data</b>					
Cable Type	C32 (Compliant to UN ECE R118 & EN45545-2)				
Cable Diameter (mm)	5 (0.2")				
Cable Length (m)	0.5m (20")				
Termination	4G/5G	4x N Socket (f)			
	WiFi	4x N Socket (f)	3x N Socket (f)	2x N Socket (f)	-
	GPS/GNSS	1x TNC Plug (m)			

\*Across 90% of relevant bands when measured on a 600 x 600mm (2' x 2') ground plane with 0.5m (20") of CS32 cable

Panorama Antennas Ltd  
Frogmore, London, SW18 1HF, United Kingdom  
T: +44 (0)20 8877 4444 | F: +44 (0)20 8877 4477  
E: sales@panorama-antennas.com  
W: www.panorama-antennas.com

17/03/2023 V4

Page 2

Waiver: The data given above is indicative of the performance of the product/s under particular conditions and does not imply a guarantee of performance. These specifications are subject to change without notice. Copyright © Panorama Antennas Ltd. All rights reserved.

# 4X4 MiMo 4G/5G

## Transit Antenna

TRNM[X]4-6-60-[X]

### Electrical Data- Cell

Measurement Conditions	4G/5G Antennas				
TRNMG4-6-60-Q measured on 600x600mm (2'x2') ground plane with 0.5m (20") CS32 Pigtails	Frequency Range (MHz)	LTE Bands	Antenna Element	Peak Gain (dBi)	Efficiency (%)
	617-698	71	Cell A	5.8	80
			Cell B	6.0	79
			Cell C	6.1	78
			Cell D	5.7	80
	699-798	12,13, 14 17,28	Cell A	6.9	82
			Cell B	6.9	82
			Cell C	7.0	82
			Cell D	6.7	81
	807- 862	5,19,20,26,27	Cell A	7.2	81
			Cell B	7.3	81
			Cell C	7.5	81
			Cell D	7.1	81
	880-960	8	Cell A	7.2	84
			Cell B	7.3	84
			Cell C	7.5	84
			Cell D	7.1	84
	1427-1518	11, 21, 74,75,76	Cell A	7.9	86
			Cell B	8.0	86
			Cell C	8.2	87
			Cell D	8.1	86
	1710-1920	2,3,4,9,25,35, 39,66	Cell A	7.3	76
			Cell B	7.1	77
			Cell C	7.1	77
			Cell D	7.1	77
	1920-2170	1,23	Cell A	8.1	76
			Cell B	8.6	77
			Cell C	8.8	77
			Cell D	8.2	77
	2300-2400	30,40	Cell A	9.1	80
			Cell B	9.2	81
			Cell C	9.5	81
			Cell D	9.1	82
	2496-2690	7,38,41	Cell A	8.4	82
			Cell B	8.4	83
			Cell C	8.5	83
			Cell D	8.7	84
	3300-4200	22,42,43,48,77, 78,79	Cell A	7.4	69
			Cell B	7.2	69
			Cell C	7.3	68
			Cell D	7.3	70
4400-5000	79	Cell A	7.1	65	
		Cell B	7.3	63	
		Cell C	7.6	67	
		Cell D	8.0	69	

# 4X4 MiMo 4G/5G

## Transit Antenna

TRNM[X]4-6-60-[X]

Electrical Data - WiFi

Measurement Conditions	WiFi Antennas				
TRNMG4-6-60-Q measured on 600x600mm (2'x2') ground plane with 0.5m (20") CS32 Pigtailes	Frequency Range (MHz)	WiFi Bands	Antenna Element	Peak Gain (dBi)	Efficiency (%)
	2396-2485	2.5GHz	WiFi 1	8.2	71
			WiFi 2	8.3	70
			WiFi 3	7.8	71
			WiFi 4	7.9	71
	5150-5250	UNII-1	WiFi 1	7.8	70
			WiFi 2	7.0	68
			WiFi 3	8.0	68
			WiFi 4	7.0	69
	5250-5350	UNII-2A	WiFi 1	7.6	69
			WiFi 2	6.6	68
			WiFi 3	7.2	68
			WiFi 4	7.2	69
	5470-5725	UNII-2B	WiFi 1	7.9	64
			WiFi 2	7.1	62
			WiFi 3	7.7	64
			WiFi 4	7.3	61
5725-5900	UNII-3	WiFi 1	8.4	62	
		WiFi 2	7.7	58	
		WiFi 3	8.5	60	
		WiFi 4	8.1	59	
5845-5885	UNII-4	WiFi 1	8.2	60	
		WiFi 2	7.5	56	
		WiFi 3	8.3	58	
		WiFi 4	7.8	57	
5935-6415	UNII-5	WiFi 1	9.0	66	
		WiFi 2	9.0	58	
		WiFi 3	9.1	61	
		WiFi 4	9.2	59	
6435-6515	UNII-6	WiFi 1	7.6	69	
		WiFi 2	7.6	58	
		WiFi 3	7.5	62	
		WiFi 4	7.9	60	
6535-6875	UNII-7	WiFi 1	8.1	71	
		WiFi 2	7.0	61	
		WiFi 3	8.3	65	
		WiFi 4	7.4	62	
6875-7125	UNII-8	WiFi 1	8.3	69	
		WiFi 2	7.8	62	
		WiFi 3	8.3	66	
		WiFi 4	7.7	61	

### Electrical Data- Cell

Typical VSWR \*

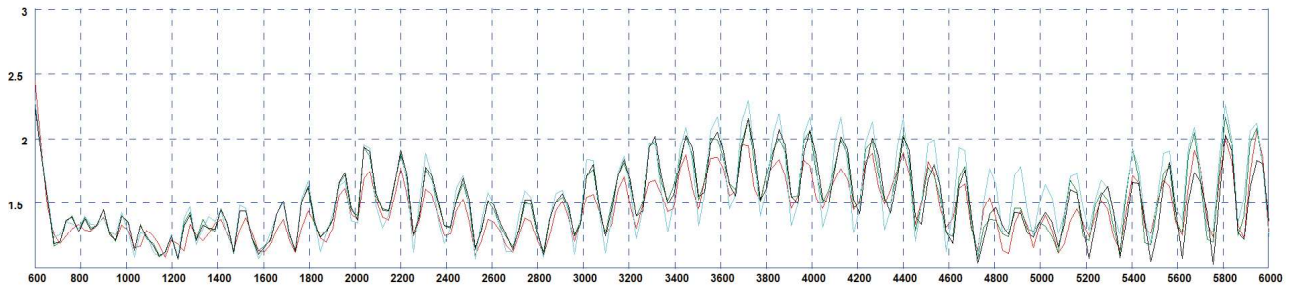

\*VSWR measured with 0.5m (1.5') of CS32 cable

Typical Efficiency\*

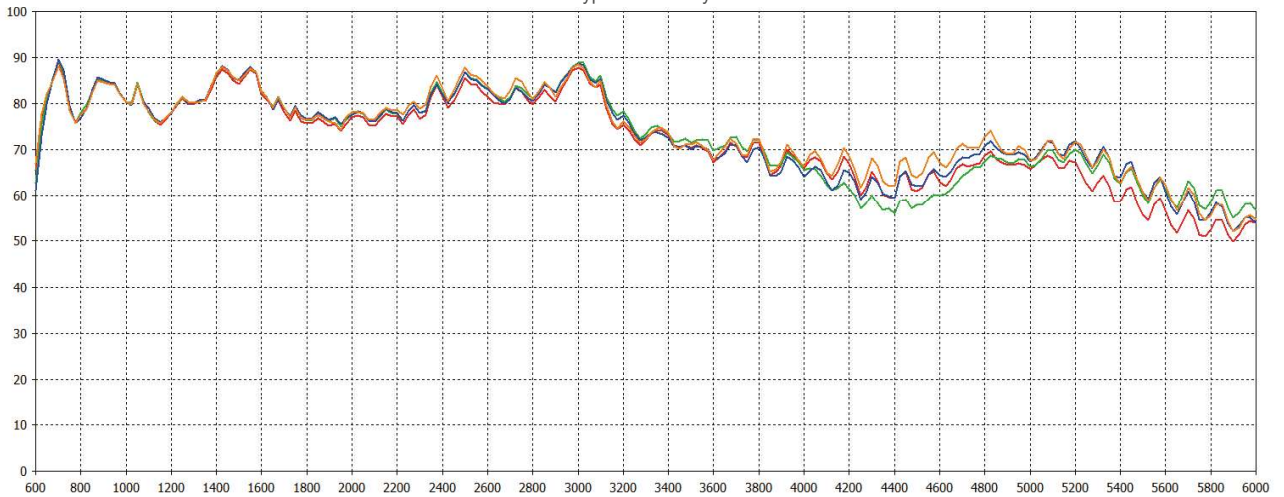

\*Efficiency measured with 0.5m (1.5') of CS32 cable

Typical Swept Peak Gain\*

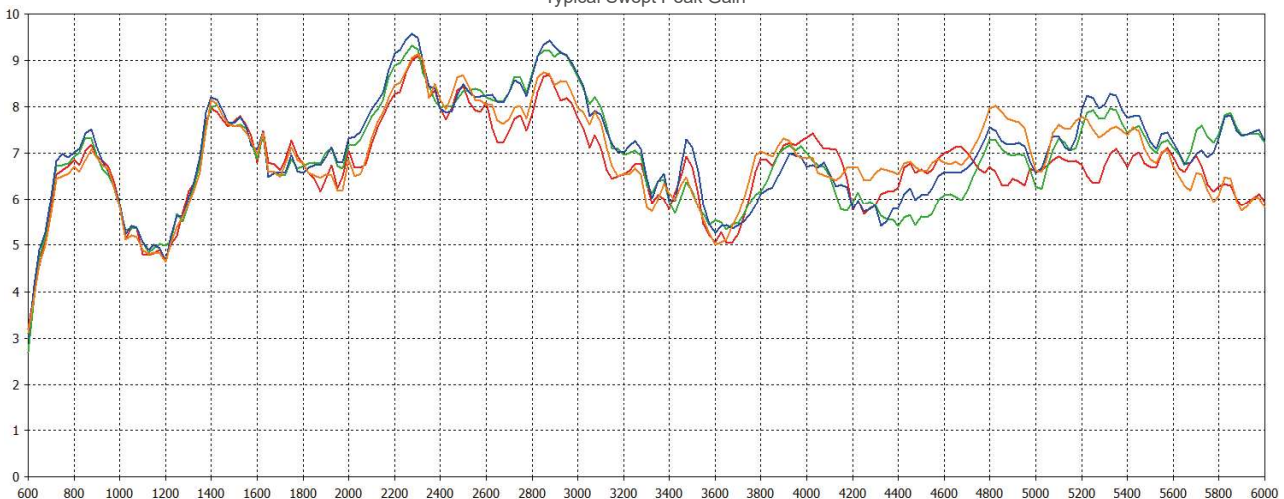

\* Swept peak gain measured with 0.5m (1.5') of CS32 cable

Typical VSWR \*

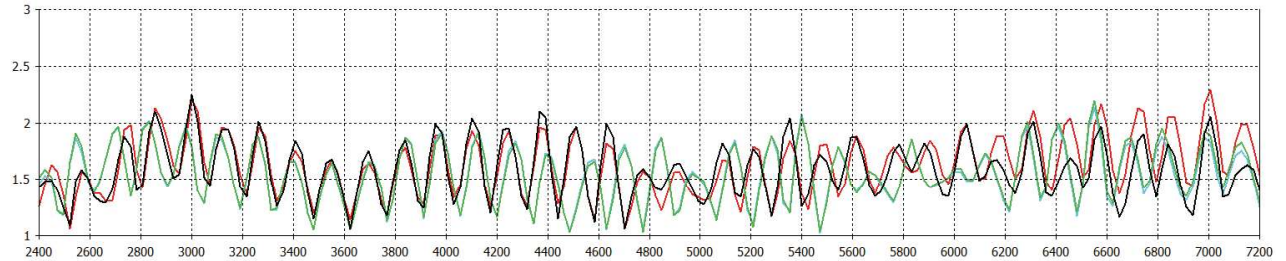

\*VSWR measured with 0.5m (1.5') of CS32 cable

Typical Efficiency\*

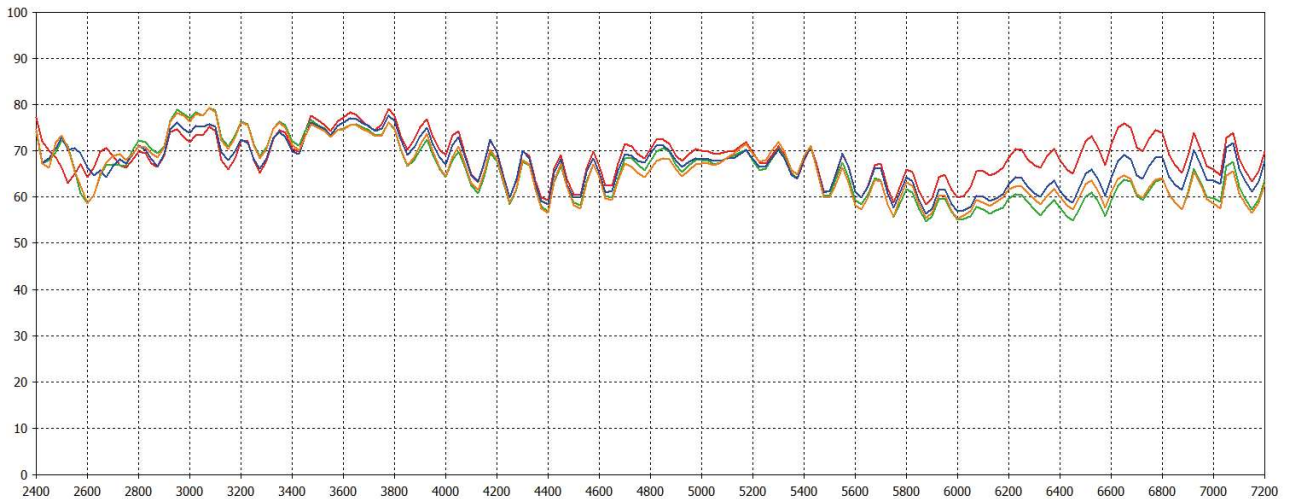

\*Efficiency measured with 0.5m (1.5') of CS32 cable

Typical Swept Peak Gain\*

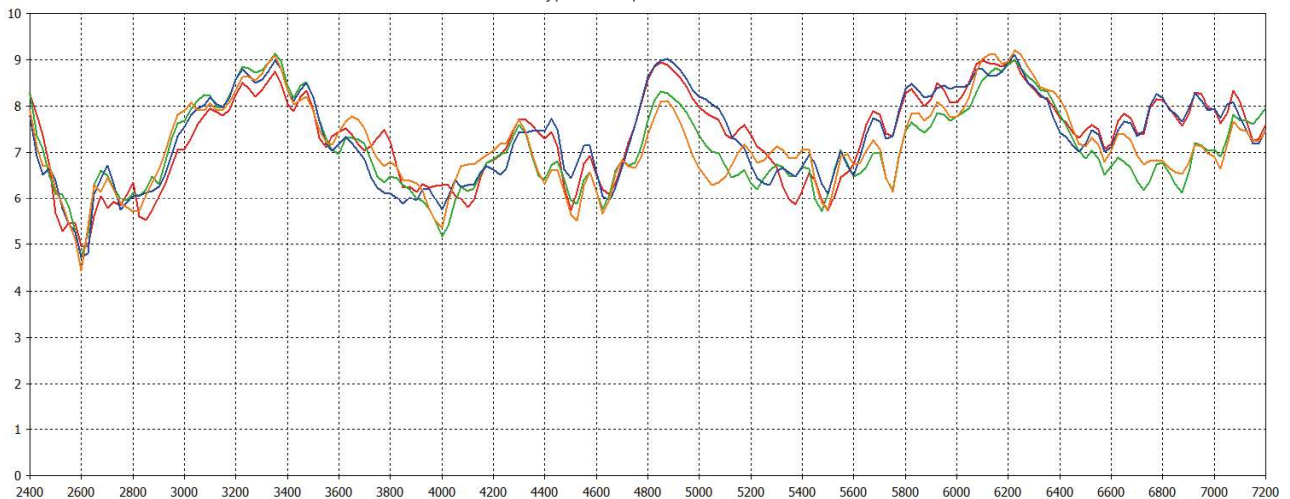

\* Swept peak gain measured with 0.5m (1.5') of CS32 cable

3D Patterns -Cell A

Typical 3D Pattern- Cell A - 650 MHz

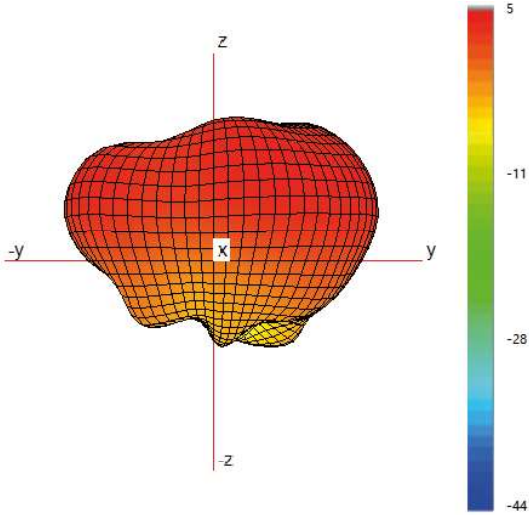

Typical H Plane- Cell A - Patterns- 600-700MHz

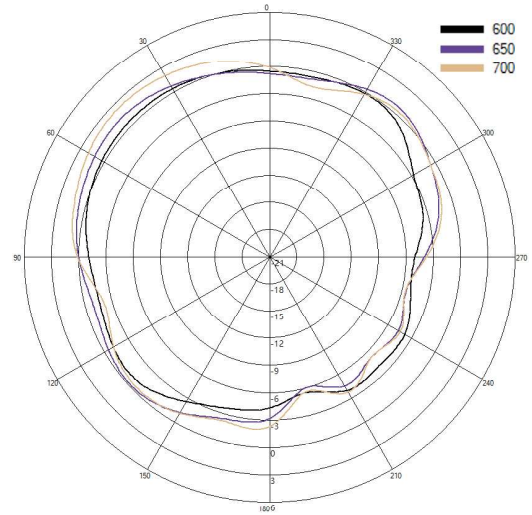

Typical 3D Pattern- Cell A - 750 MHz

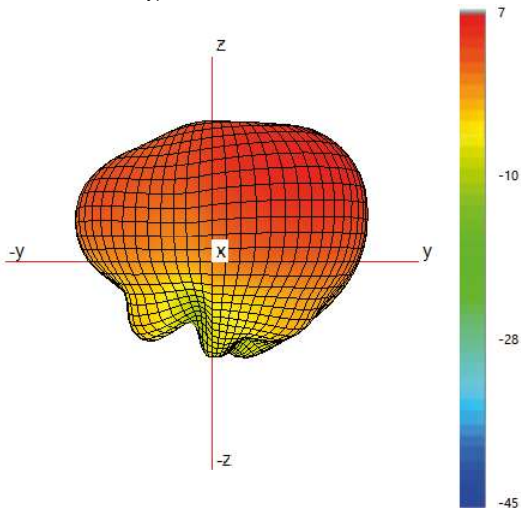

Typical H Plane- Cell A - Patterns- 700-800MHz

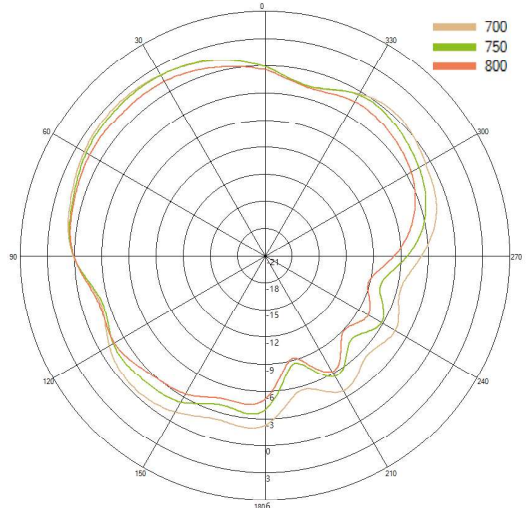

Typical 3D Pattern- Cell A - 850 MHz

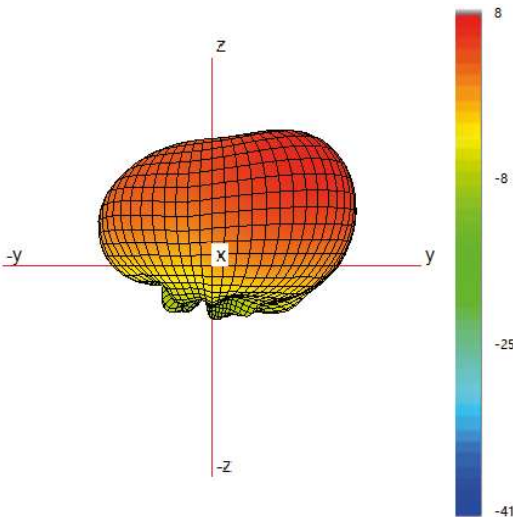

Typical H Plane- Cell A - Patterns- 800-900MHz

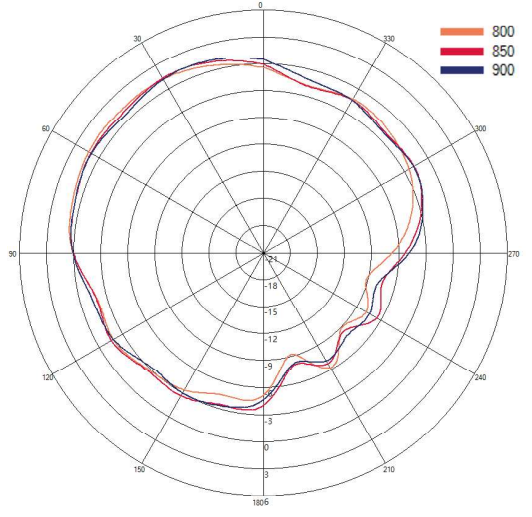

3D Patterns Cell A

Typical 3D Pattern- Cell A - 1475 MHz

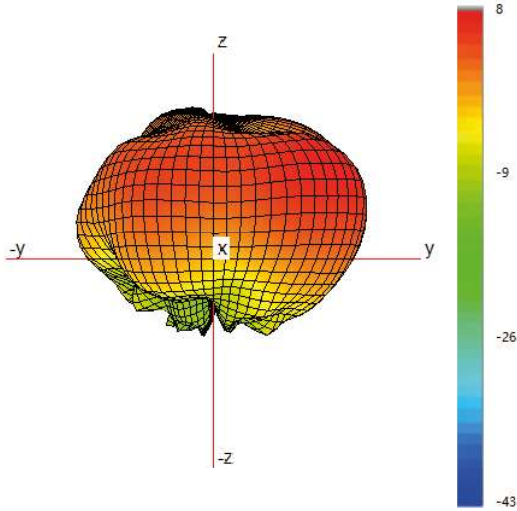

Typical H Plane- Cell A- Patterns- 1450-1500 MHz

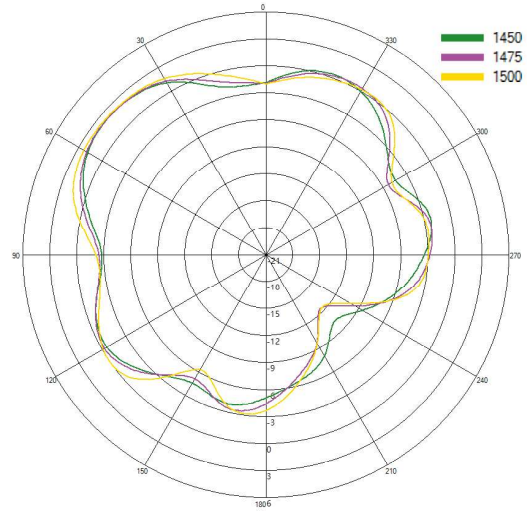

Typical 3D Pattern- Cell A - 1800 MHz

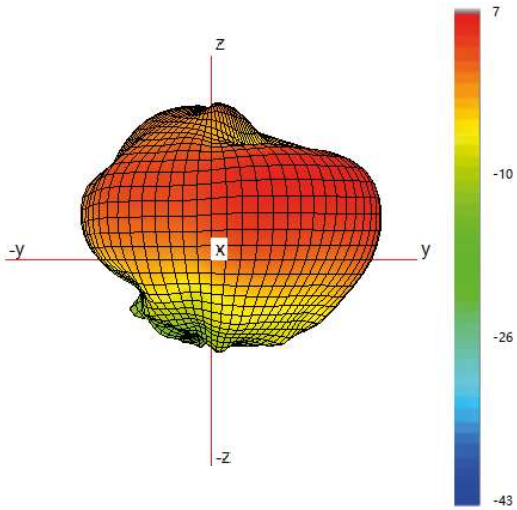

Typical H Plane- Cell A- Patterns- 1750-1850 MHz

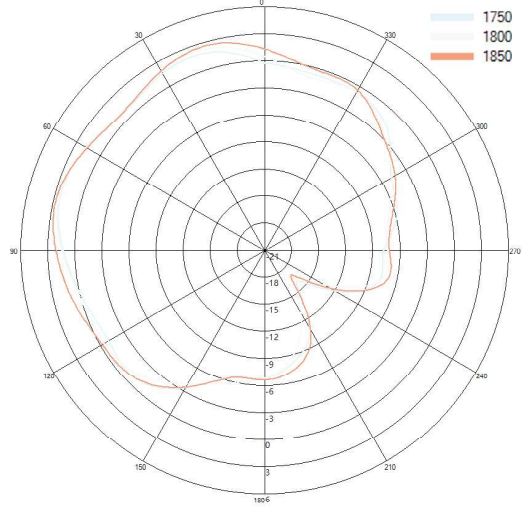

Typical 3D Pattern- Cell A - 2150 MHz

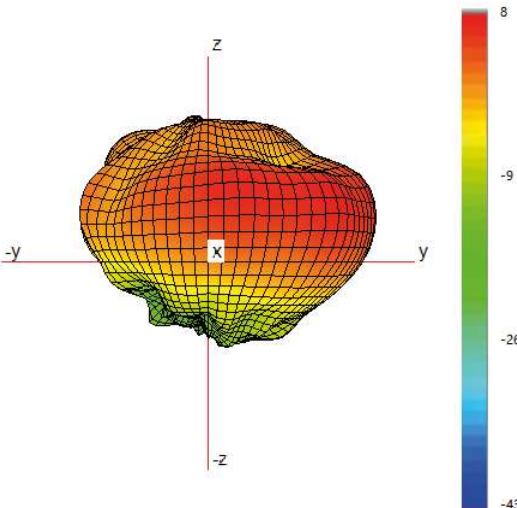

Typical H Plane- Cell A- Patterns- 2100-2200 MHz

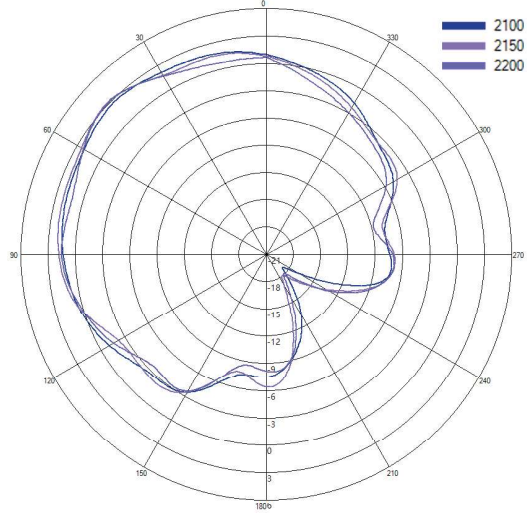



3D Patterns -Cell A

Typical 3D Pattern- Cell A - 2350 MHz

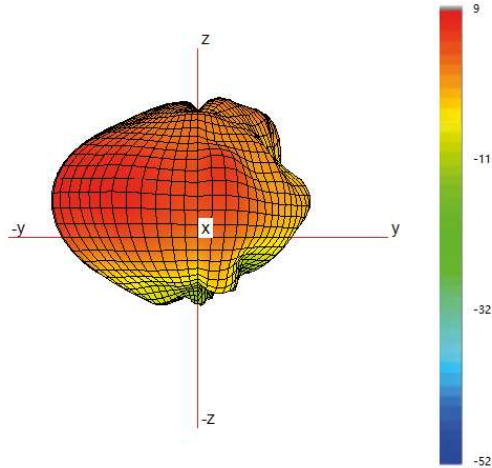

Typical H Plane- Cell A - Patterns- 2300-2400 MHz

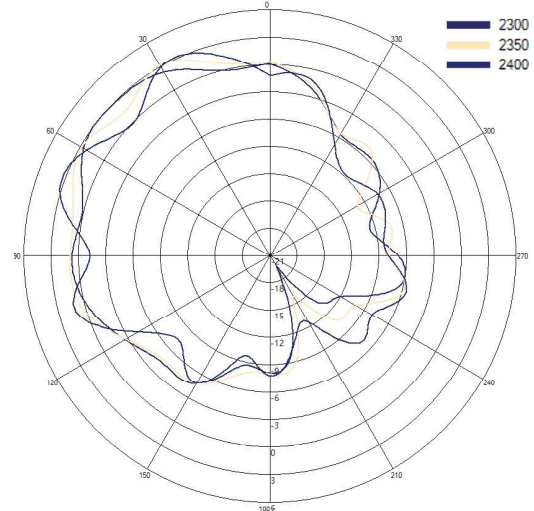

Typical 3D Pattern- Cell A - 2650 MHz

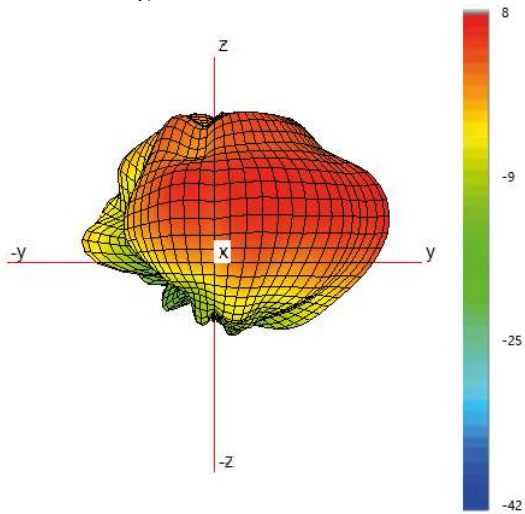

Typical H Plane- Cell A - Patterns- 2600-2700 MHz

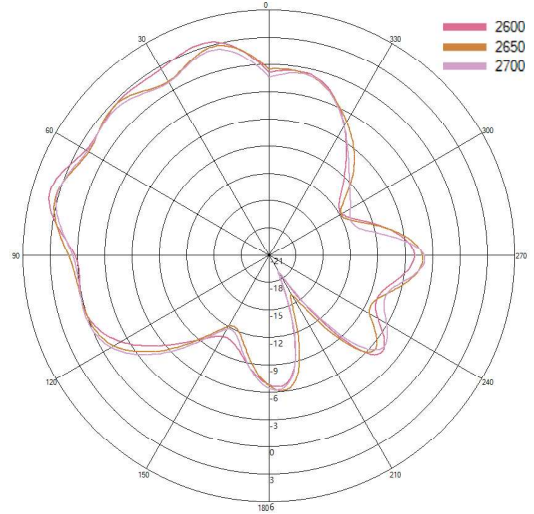

Typical 3D Pattern- Cell A - 3600 MHz

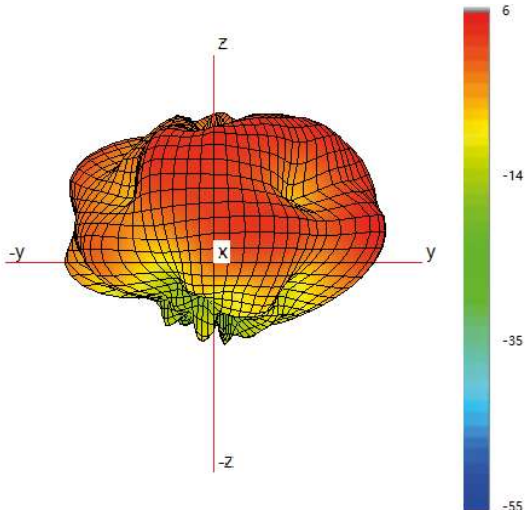

Typical H Plane- Cell A - Patterns- 3400-3800 MHz

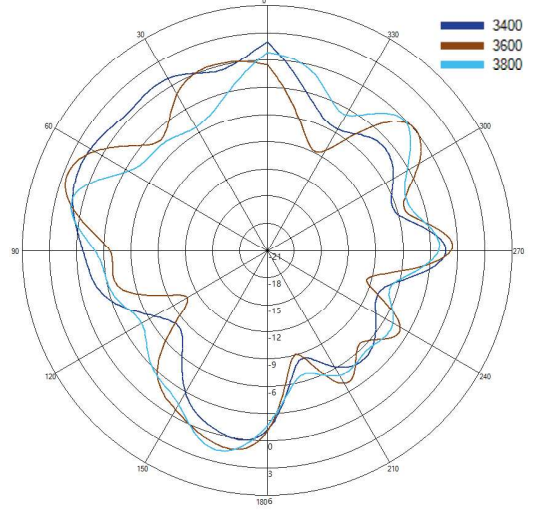

3D Patterns Cell A

Typical 3D Pattern- Cell A - 5600 MHz

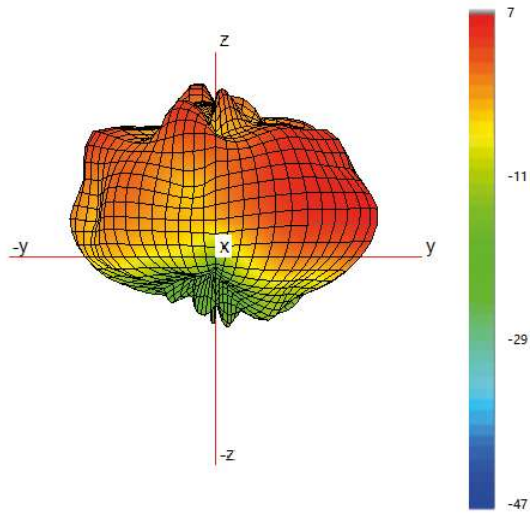

Typical H Plane- Cell A - Patterns- 5400-5800 MHz

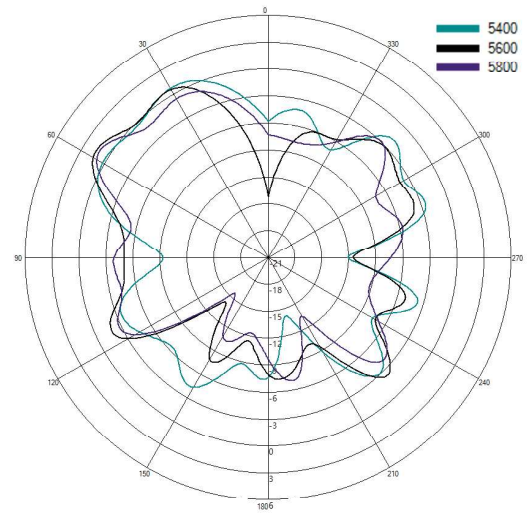

3D Patterns -Cell B

Typical 3D Pattern- Cell B - 650 MHz

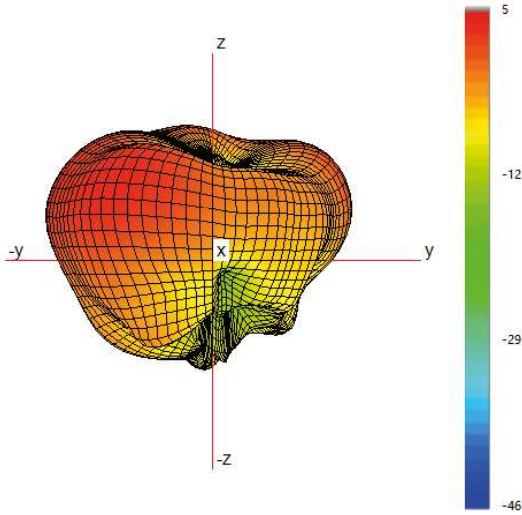

Typical H Plane- Cell B - Patterns- 600-700MHz

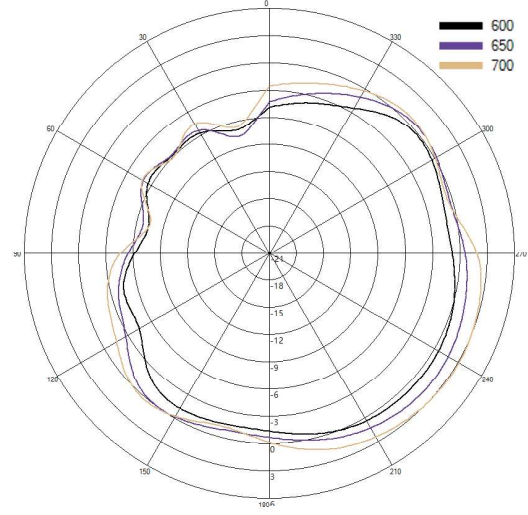

Typical 3D Pattern- Cell B - 750 MHz

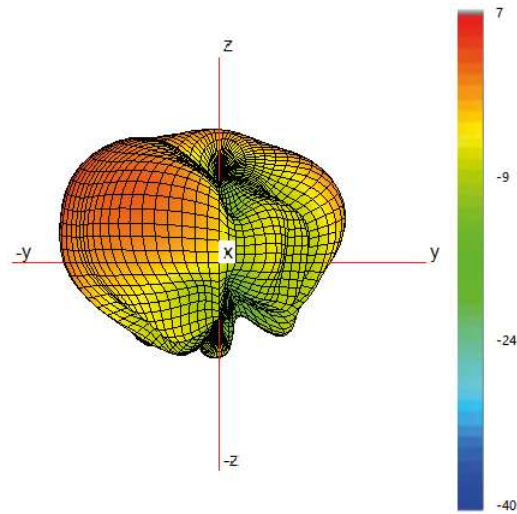

Typical H Plane- Cell B - Patterns- 700-800MHz

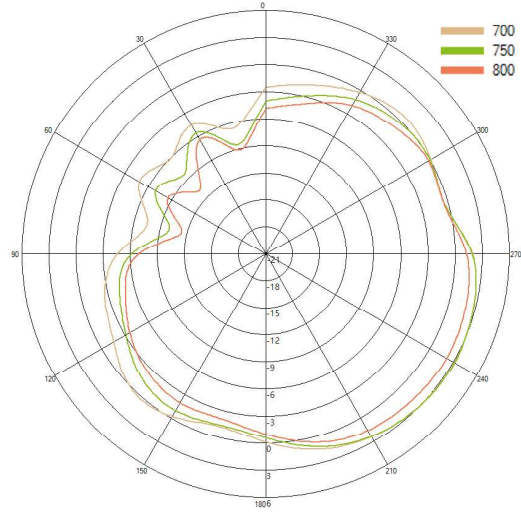

Typical 3D Pattern- Cell B - 850 MHz

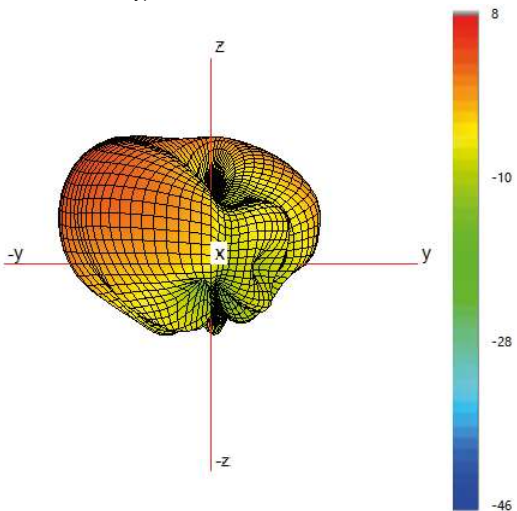

Typical H Plane- Cell B - Patterns- 800-900MHz

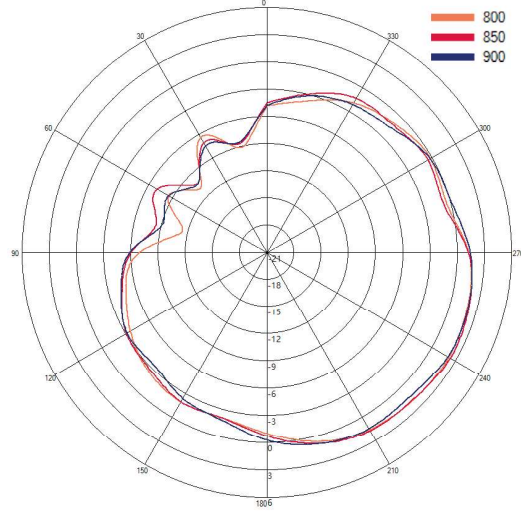

3D Patterns Cell B

Typical 3D Pattern- Cell B - 1475 MHz

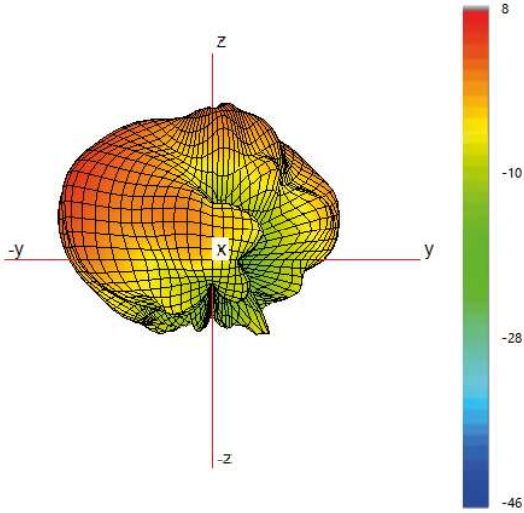

Typical H Plane- Cell B- Patterns- 1450-1500 MHz

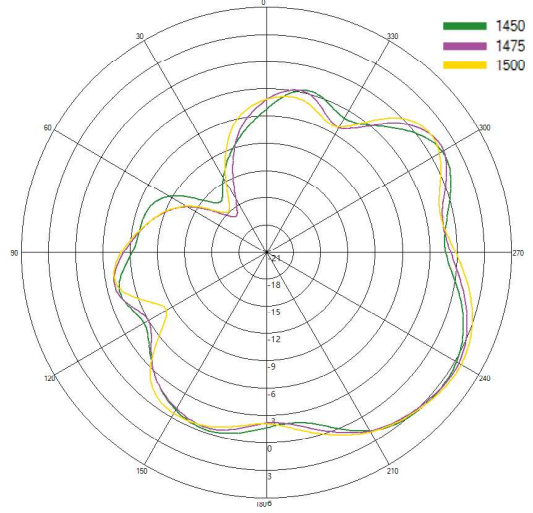

Typical 3D Pattern- Cell B - 1800 MHz

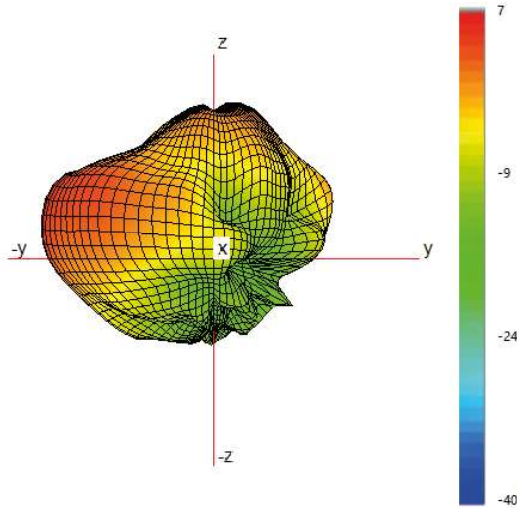

Typical H Plane- Cell B- Patterns- 1750-1850 MHz

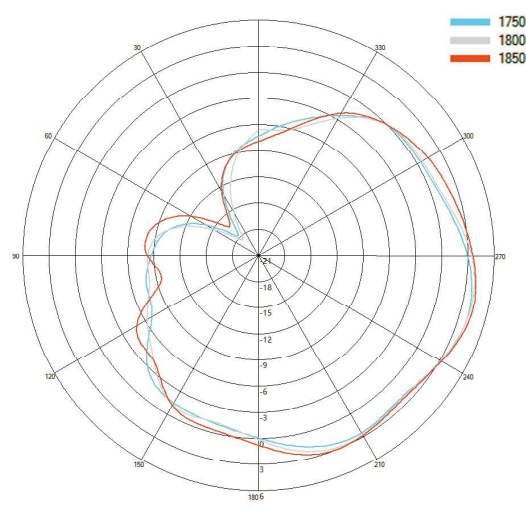

Typical 3D Pattern- Cell B - 2150 MHz

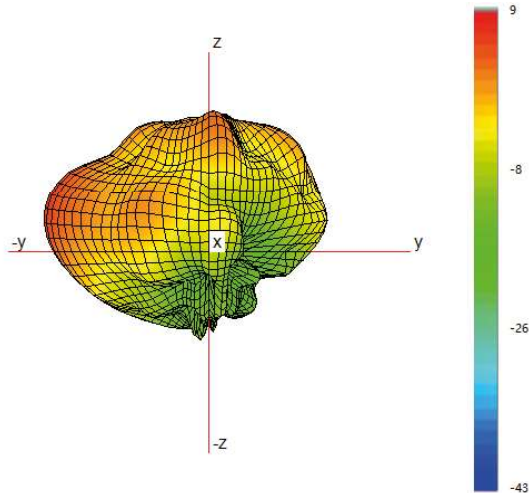

Typical H Plane- Cell B- Patterns- 2100-2200 MHz

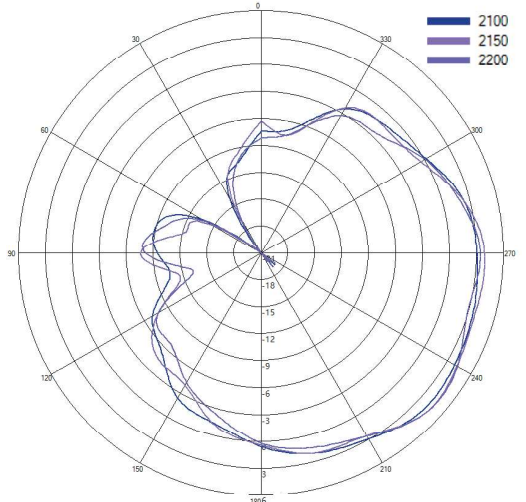

### 3D Patterns -Cell B

Typical 3D Pattern- Cell B - 2350 MHz

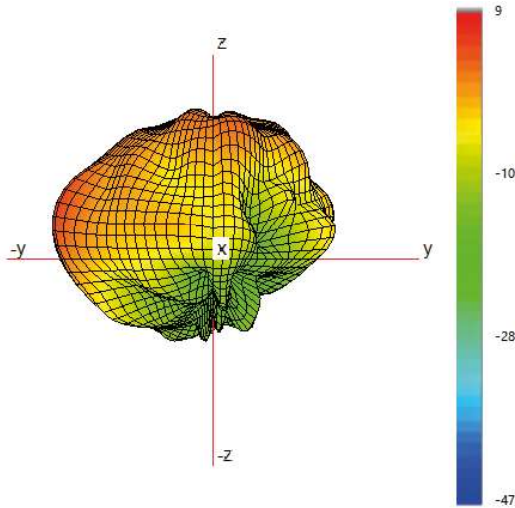

Typical H Plane- Cell B - Patterns- 2300-2400 MHz

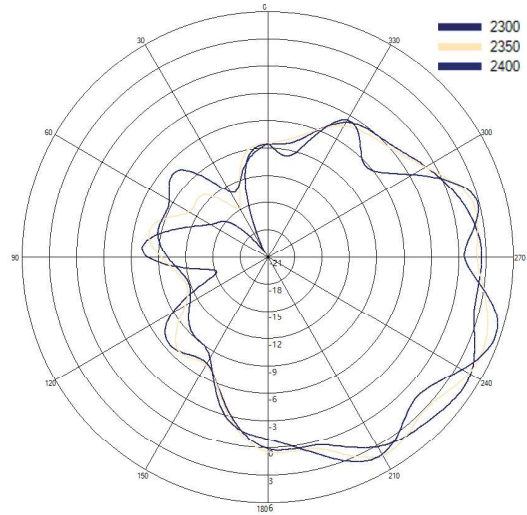

Typical 3D Pattern- Cell B - 2650 MHz

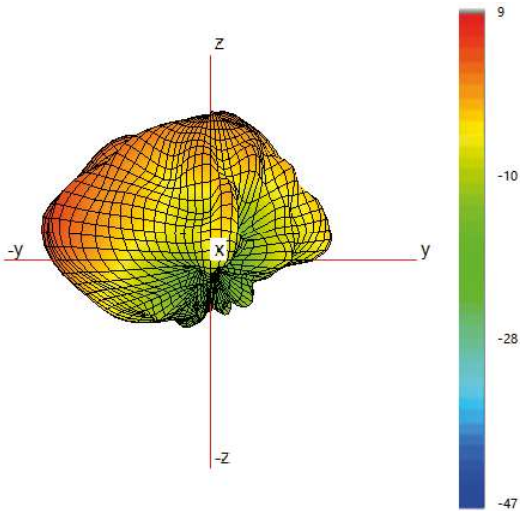

Typical H Plane- Cell B - Patterns- 2600-2700 MHz

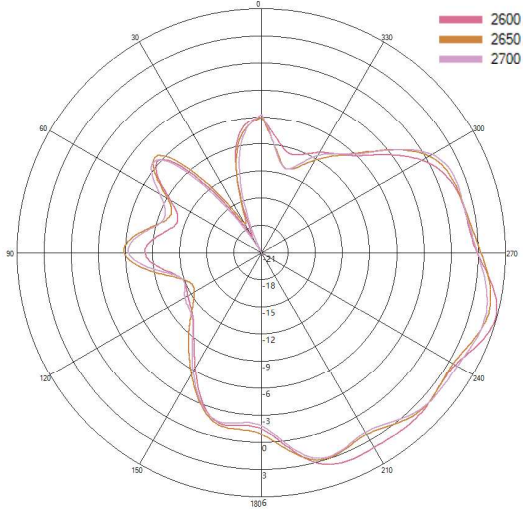

Typical 3D Pattern- Cell B - 3600 MHz

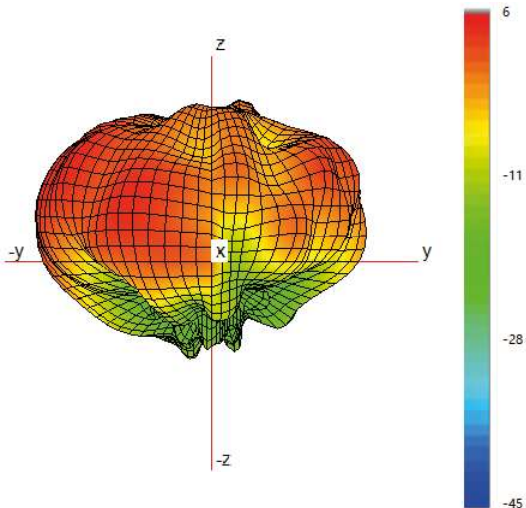

Typical H Plane- Cell B - Patterns- 3400-3800 MHz

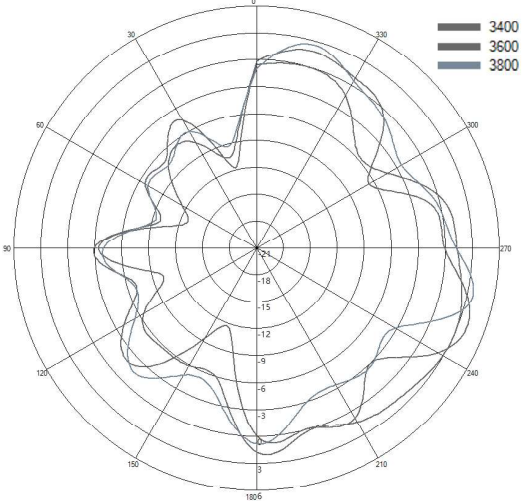

### 3D Patterns Cell B

Typical 3D Pattern- Cell B - 5600 MHz

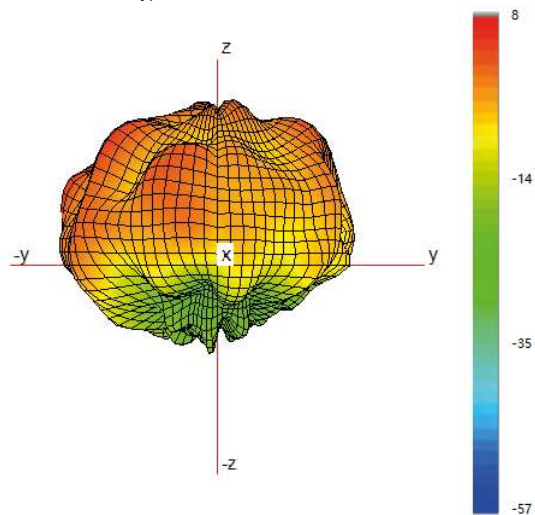

Typical H Plane- Cell B - Patterns- 5400-5800 MHz

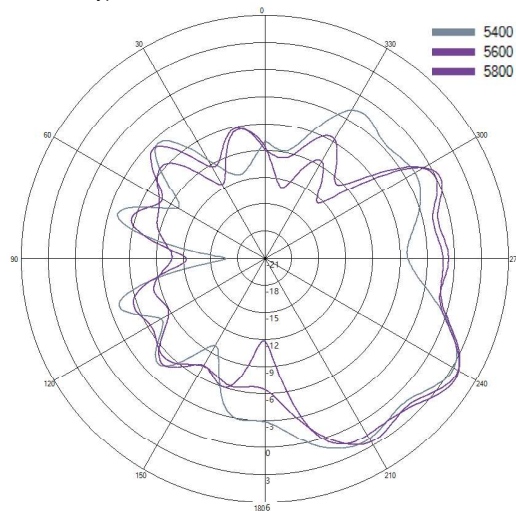

3D Patterns -Cell C

Typical 3D Pattern- Cell C - 650 MHz

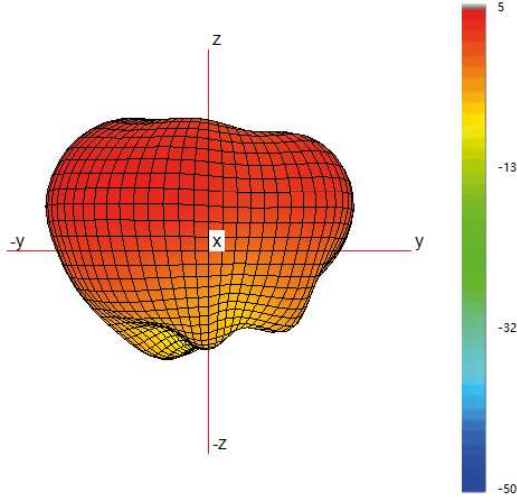

Typical H Plane- Cell C - Patterns- 600-700MHz

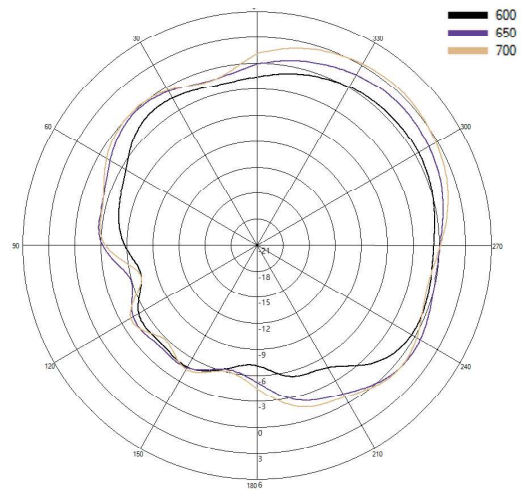

Typical 3D Pattern- Cell C - 750 MHz

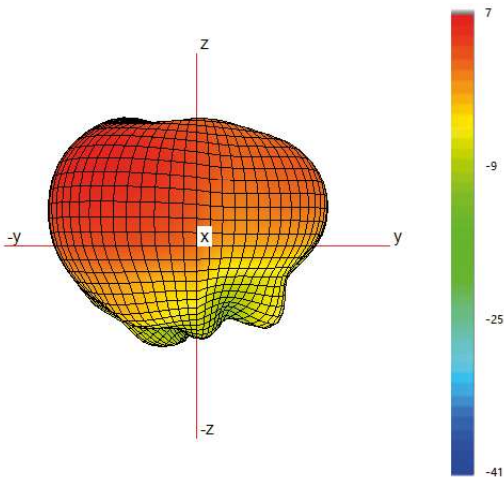

Typical H Plane- Cell C - Patterns- 700-800MHz

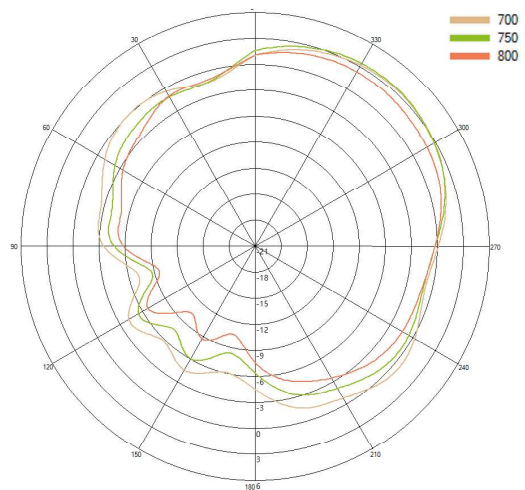

Typical 3D Pattern- Cell C - 850 MHz

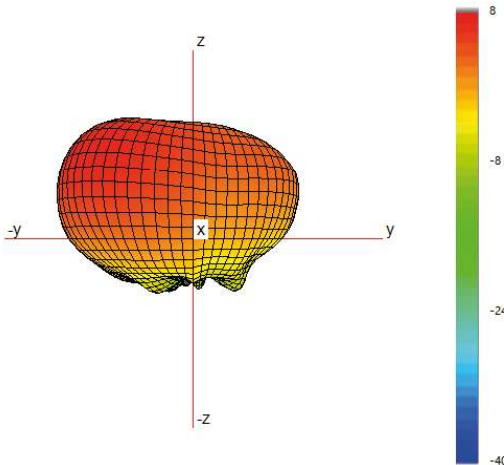

Typical H Plane- Cell C - Patterns- 800-900MHz

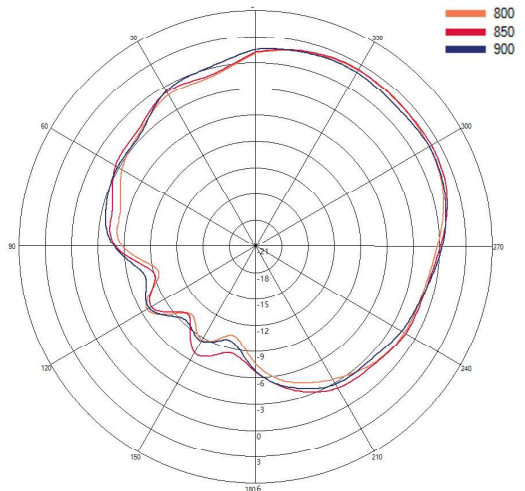

3D Patterns Cell C

Typical 3D Pattern- Cell C - 1475 MHz

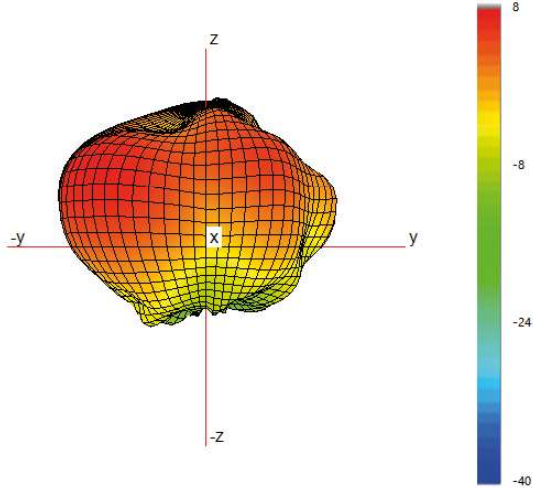

Typical H Plane- Cell C- Patterns- 1450-1500 MHz

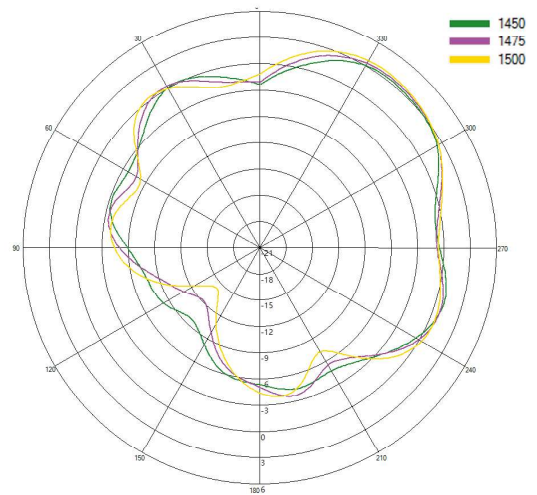

Typical 3D Pattern- Cell C - 1800 MHz

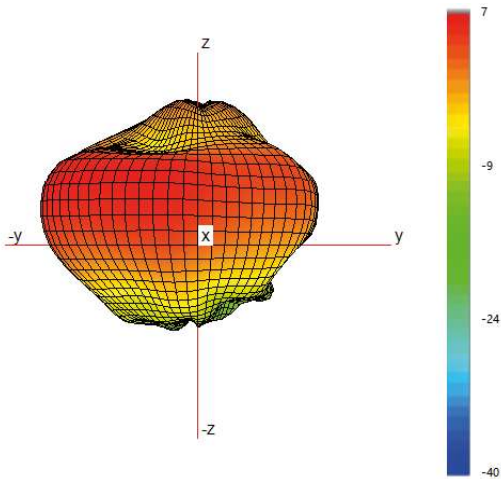

Typical H Plane- Cell C- Patterns- 1750-1850 MHz

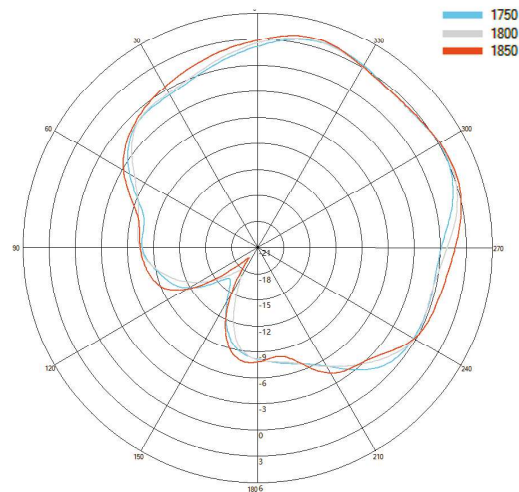

Typical 3D Pattern- Cell C - 2150 MHz

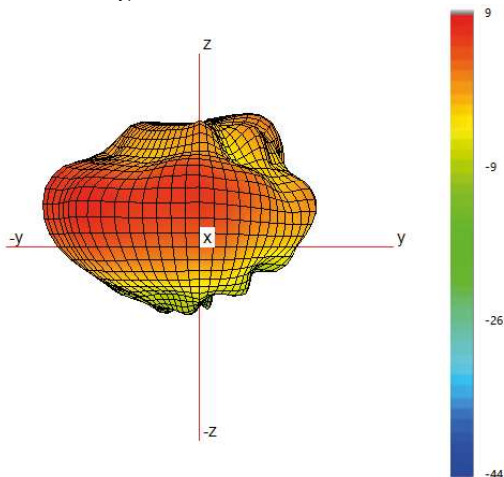

Typical H Plane- Cell C- Patterns- 2100-2200 MHz

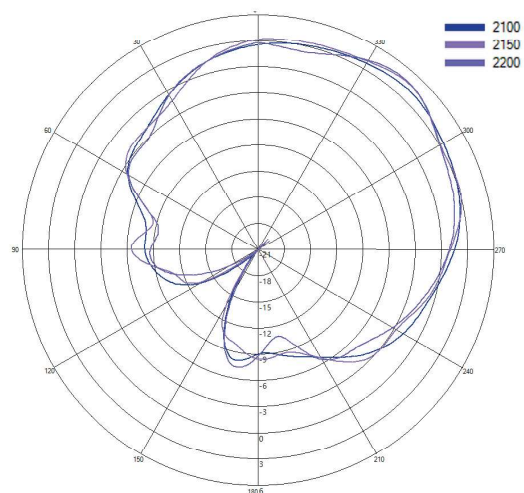



### 3D Patterns -Cell C

Typical 3D Pattern- Cell C - 2350 MHz

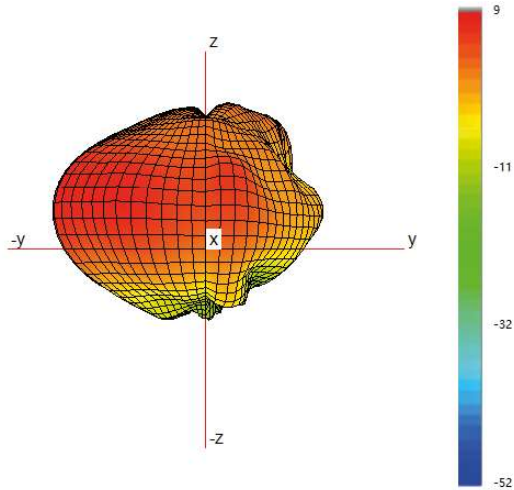

Typical H Plane- Cell C - Patterns- 2300-2400 MHz

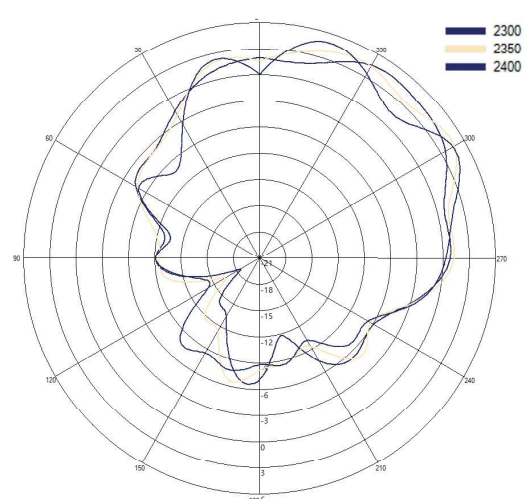

Typical 3D Pattern- Cell C - 2650 MHz

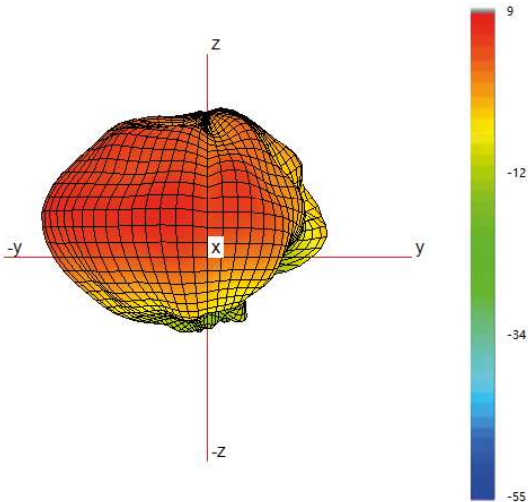

Typical H Plane- Cell C - Patterns- 2600-2700 MHz

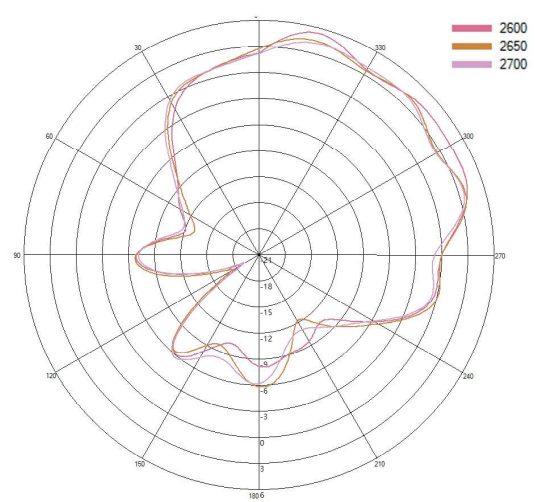

Typical 3D Pattern- Cell C - 3600 MHz

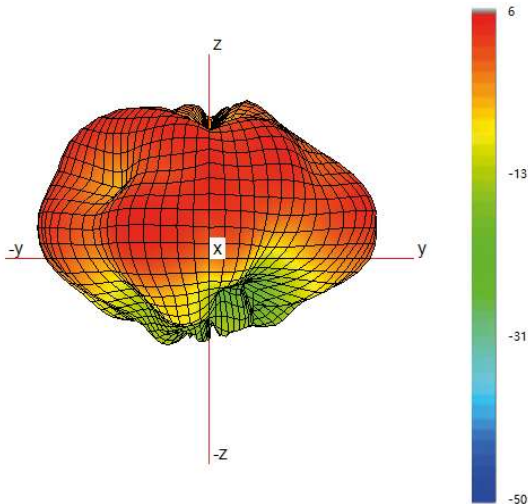

Typical H Plane- Cell C - Patterns- 3400-3800 MHz

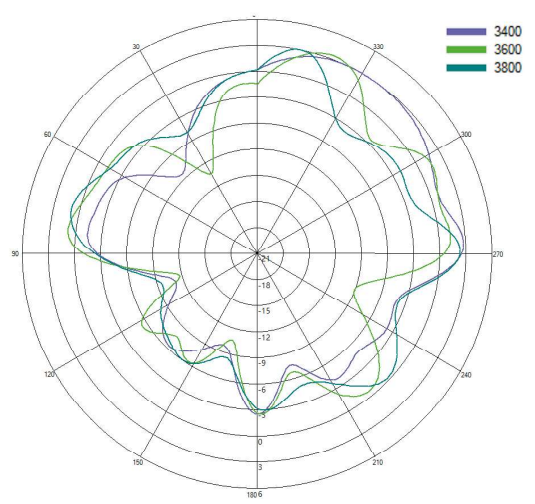

3D Patterns Cell C

Typical 3D Pattern- Cell C - 5600 MHz

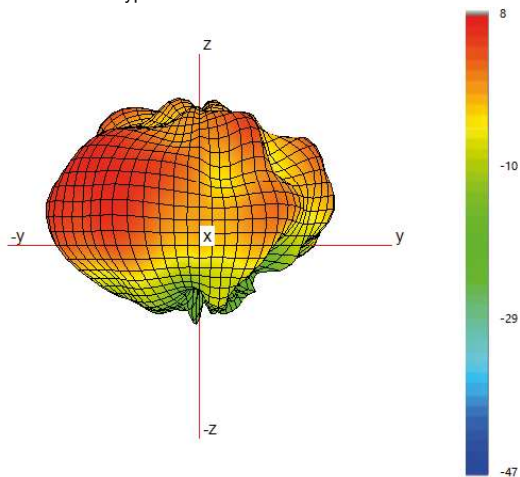

Typical H Plane- Cell C - Patterns- 5400-5800 MHz

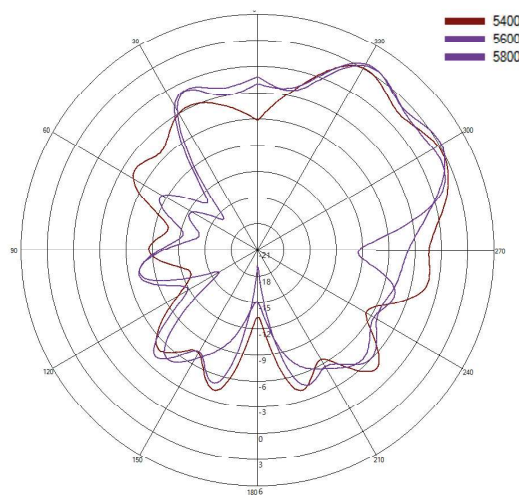

3D Patterns -Cell D

Typical 3D Pattern- Cell D - 650 MHz

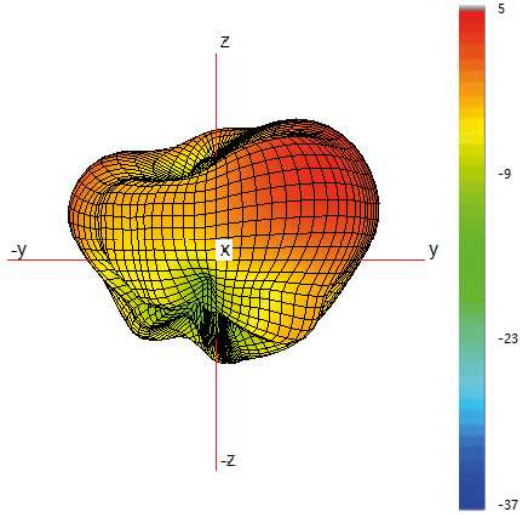

Typical H Plane- Cell D - Patterns- 600-700MHz

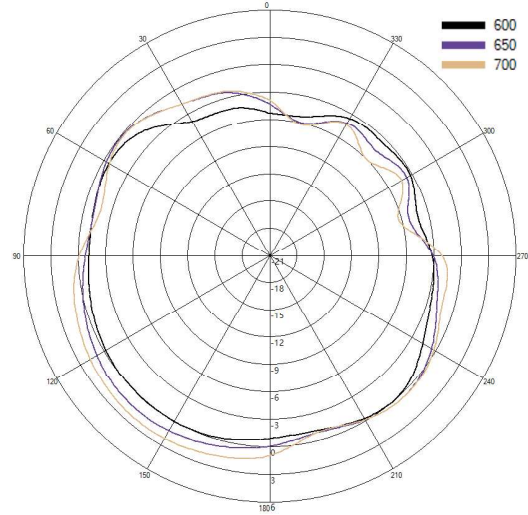

Typical 3D Pattern- Cell D - 750 MHz

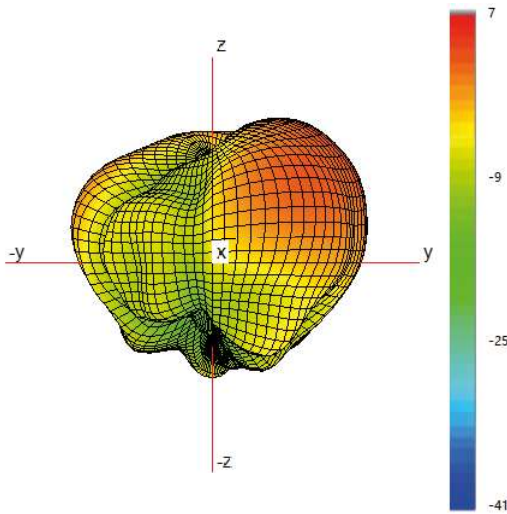

Typical H Plane- Cell D - Patterns- 700-800MHz

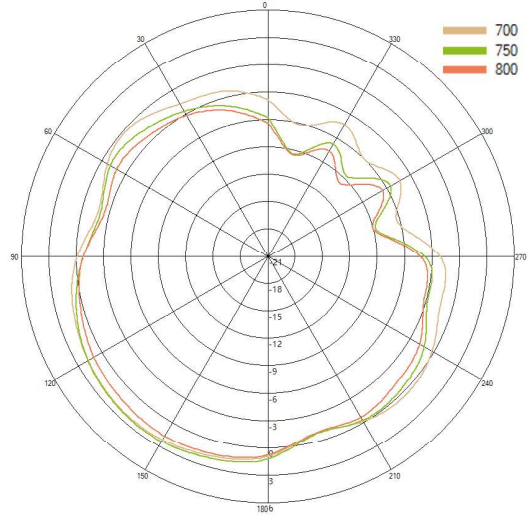

Typical 3D Pattern- Cell D - 850 MHz

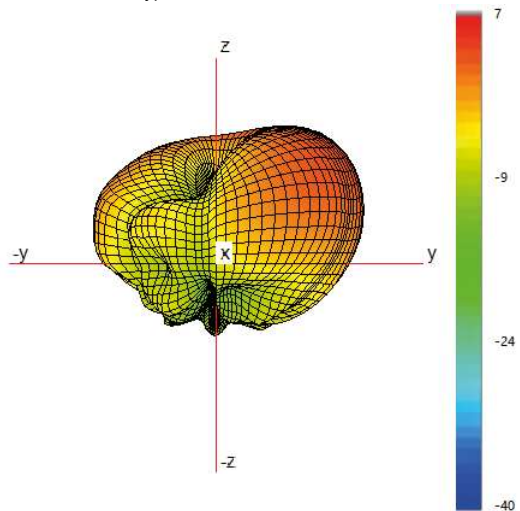

Typical H Plane- Cell D - Patterns- 800-900MHz

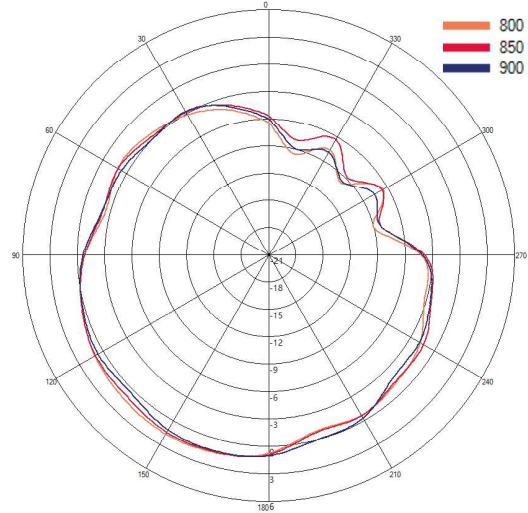

3D Patterns Cell D

Typical 3D Pattern- Cell D - 1475 MHz

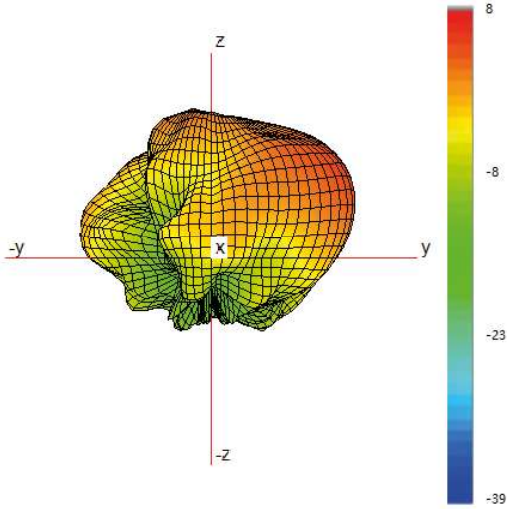

Typical H Plane- Cell D- Patterns- 1450-1500 MHz

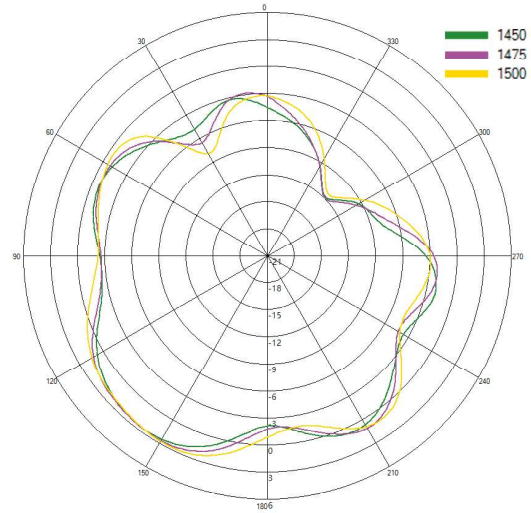

Typical 3D Pattern- Cell D - 1800 MHz

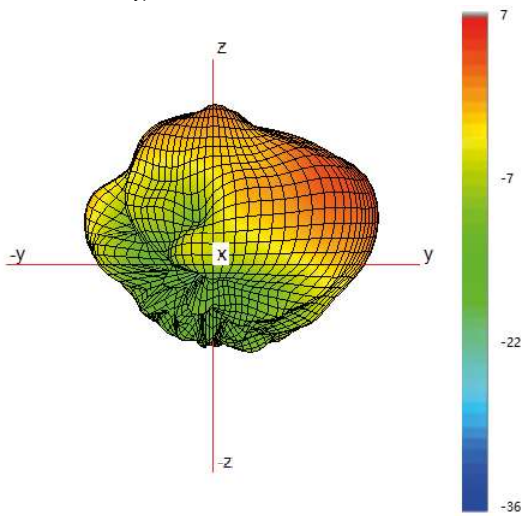

Typical H Plane- Cell D- Patterns- 1750-1850 MHz

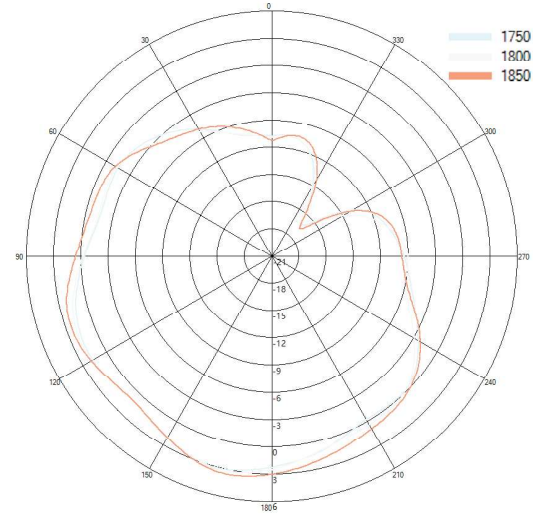

Typical 3D Pattern- Cell D - 2150 MHz

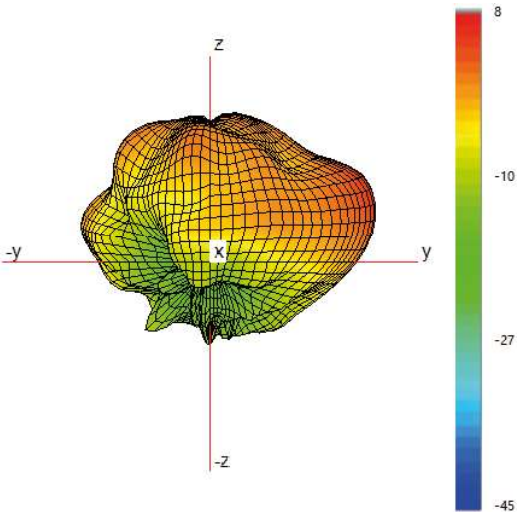

Typical H Plane- Cell D- Patterns- 2100-2200 MHz

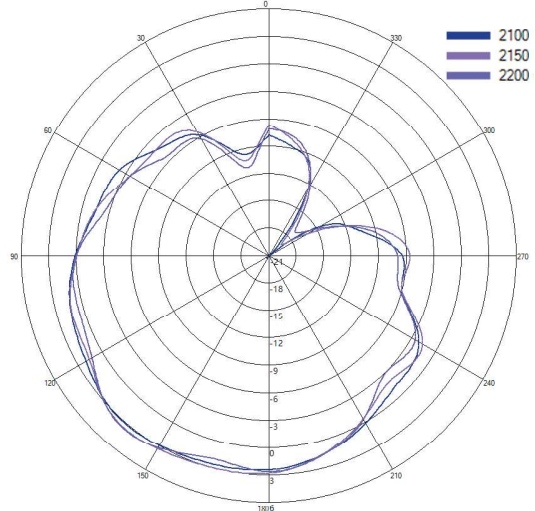

3D Patterns -Cell D

Typical 3D Pattern- Cell D - 2350 MHz

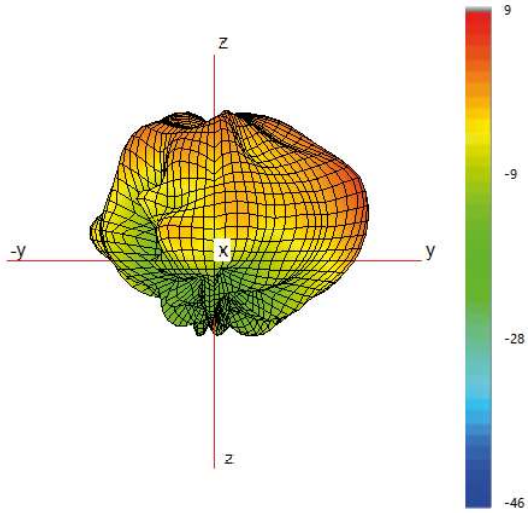

Typical H Plane- Cell D - Patterns- 2300-2400 MHz

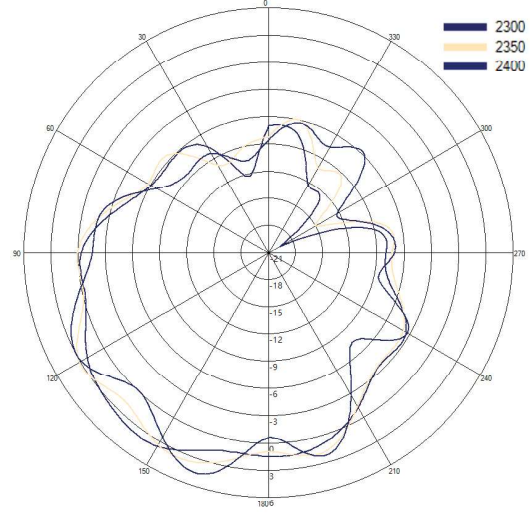

Typical 3D Pattern- Cell D - 2650 MHz

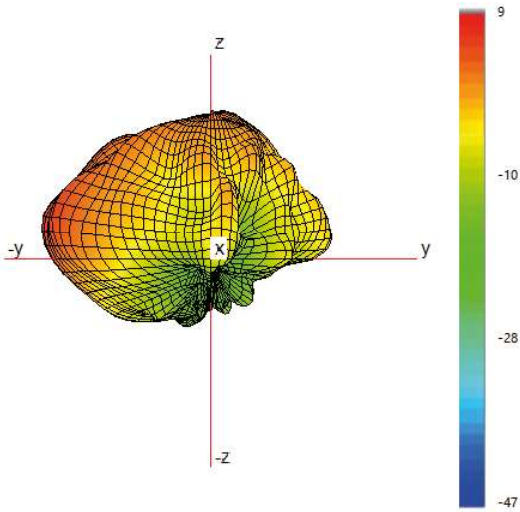

Typical H Plane- Cell D - Patterns- 2600-2700 MHz

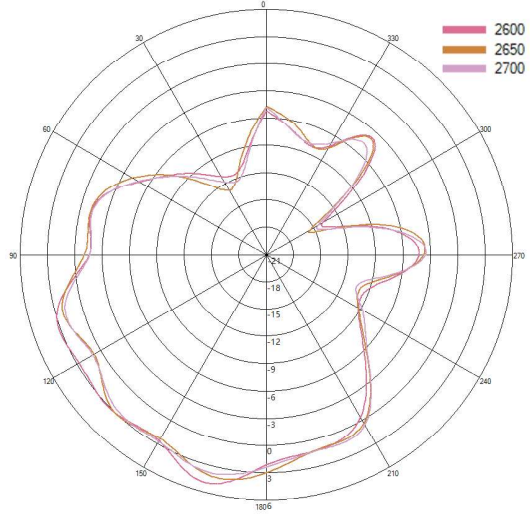

Typical 3D Pattern- Cell D - 3600 MHz

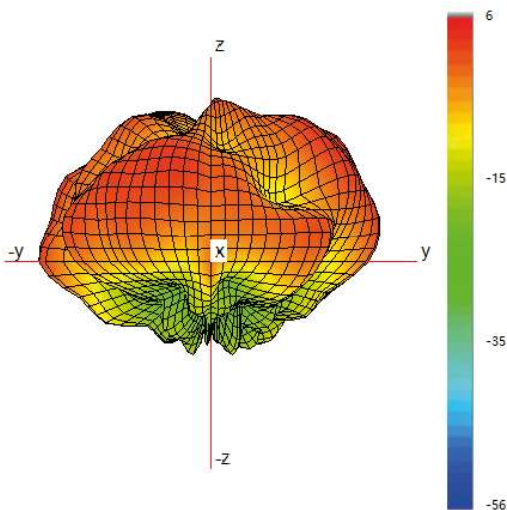

Typical H Plane- Cell D - Patterns- 3400-3800 MHz

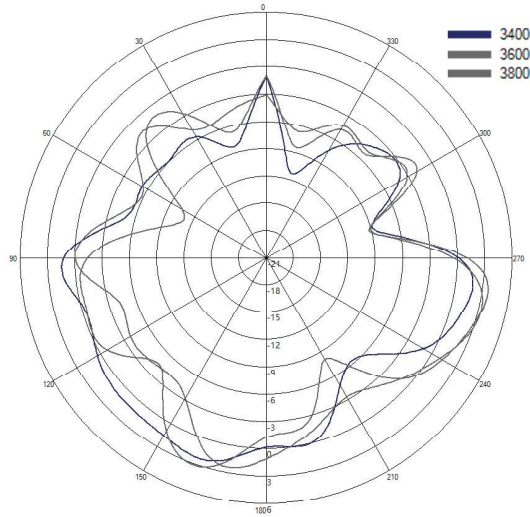

3D Patterns Cell D

Typical 3D Pattern- Cell D - 5600 MHz

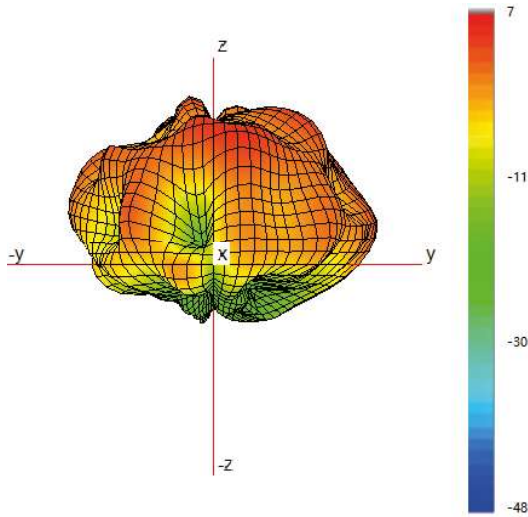

Typical H Plane- Cell D - Patterns- 5400-5800 MHz

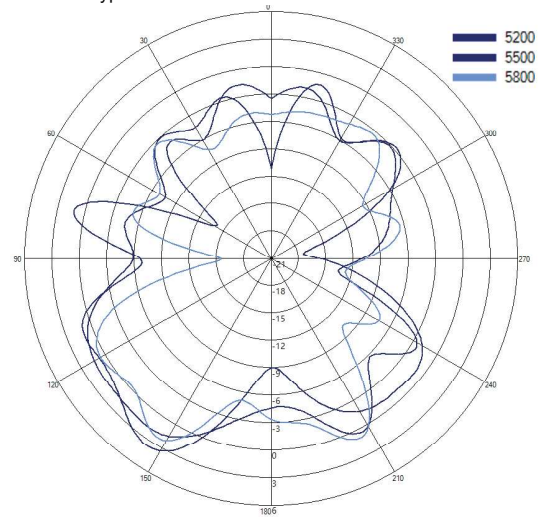

WiFi Patterns -WiFi -1

Typical 3D Pattern- WiFi - 1 - 2450 MHz

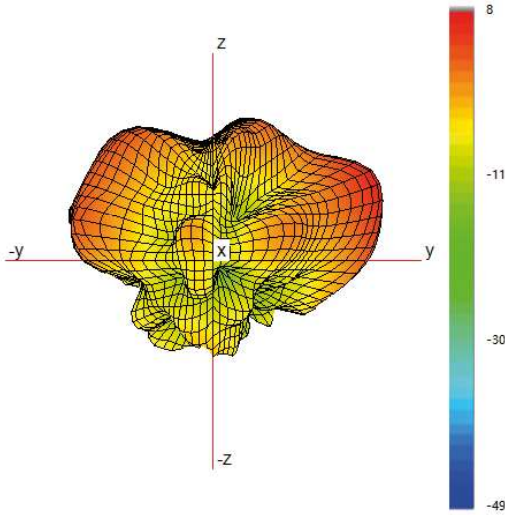

Typical H Plane- WiFi - 1 - Patterns- 2400-2475MHz

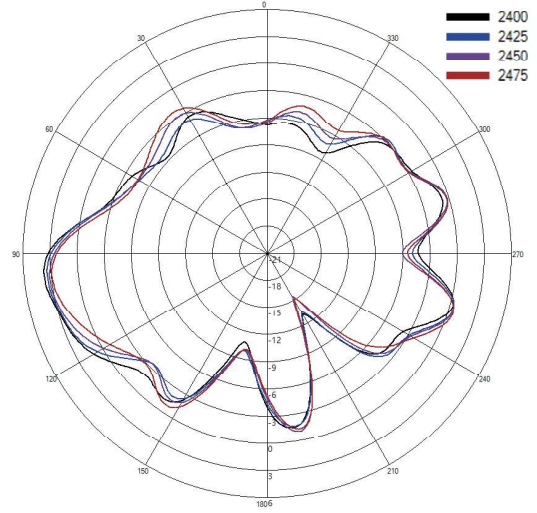

Typical 3D Pattern- WiFi - 1 - 5500 MHz

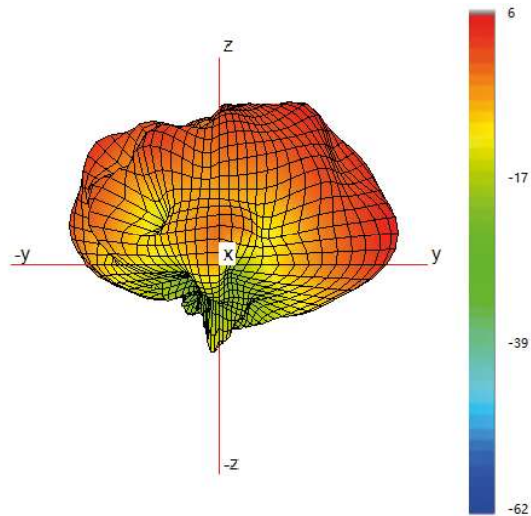

Typical H Plane- WiFi - 1 - Patterns- 5200-5800MHz

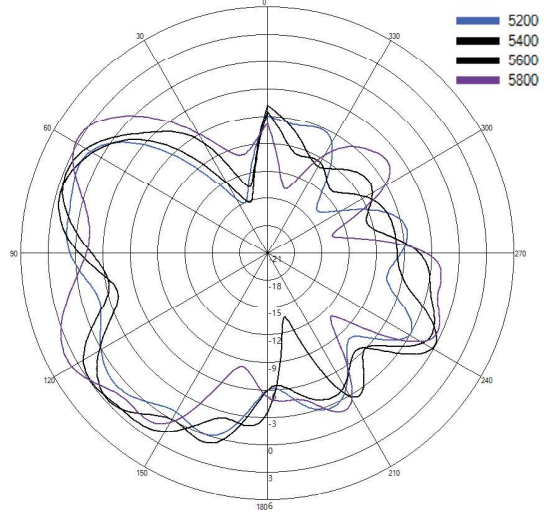

Typical 3D Pattern- WiFi - 1 - 6500 MHz

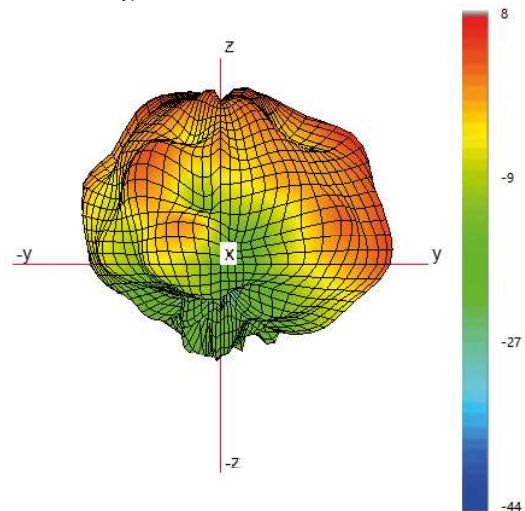

Typical H Plane- WiFi - 1 - Patterns- 6200-6800MHz

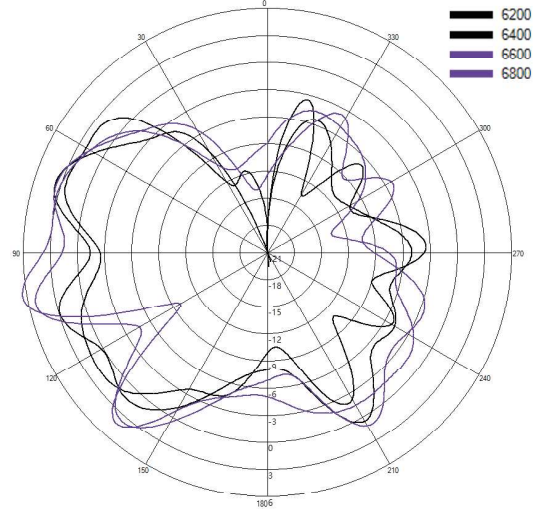

Typical 3D Pattern- WiFi - 2 - 2450 MHz

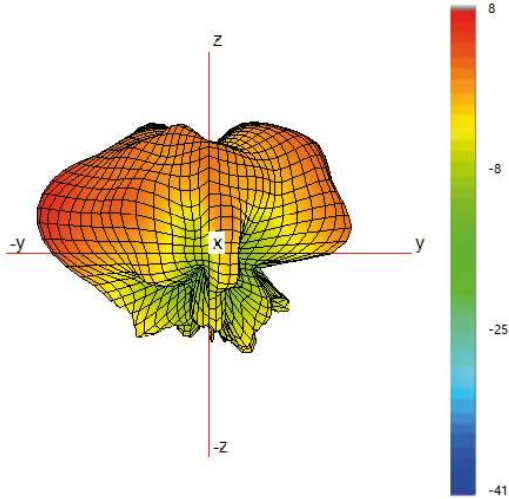

Typical H Plane- WiFi - 2 - Patterns- 2400-2475MHz

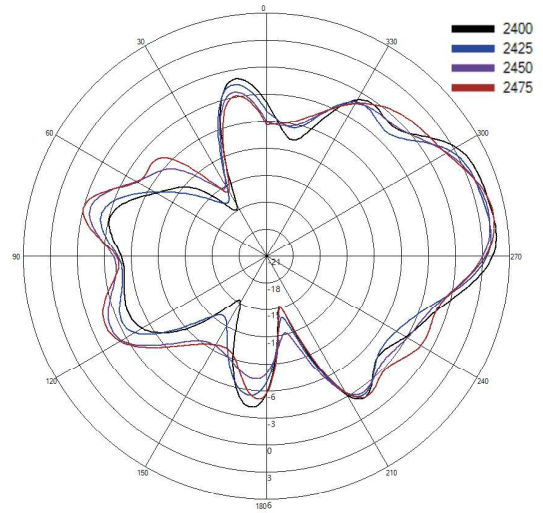

Typical 3D Pattern- WiFi - 2 - 5500 MHz

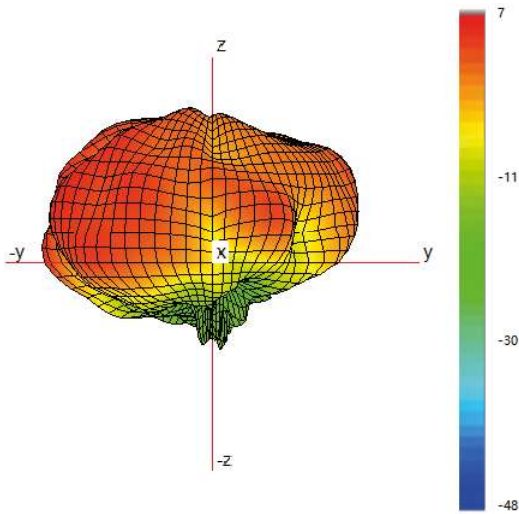

Typical H Plane- WiFi - 2 - Patterns- 5200-5800MHz

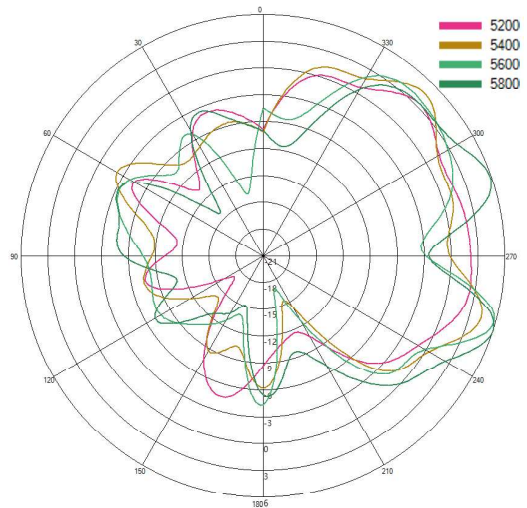

Typical 3D Pattern- WiFi - 2 - 6500 MHz

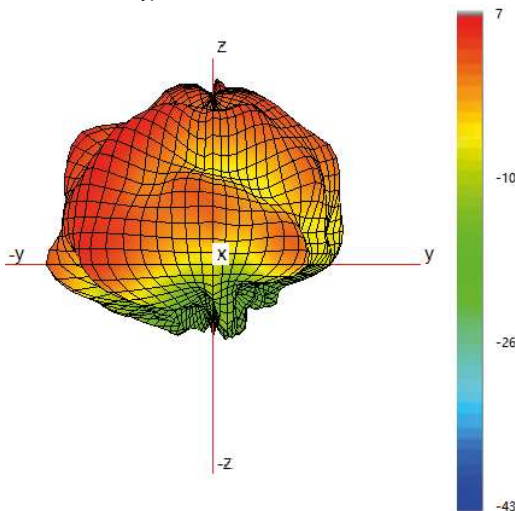

Typical H Plane- WiFi - 2 - Patterns- 6200-6800MHz

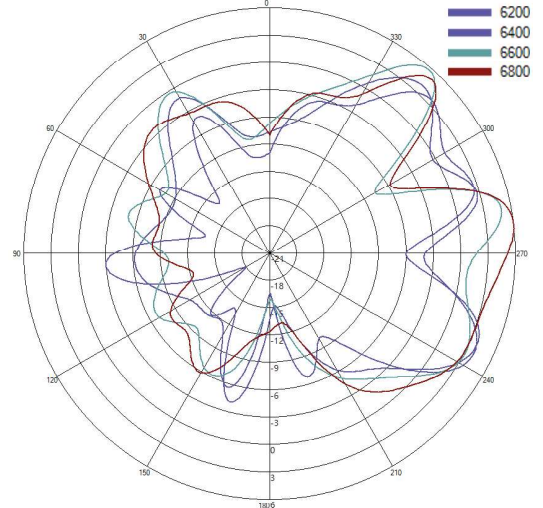



WiFi Patterns -WiFi -3

Typical 3D Pattern- WiFi - 3 - 2450 MHz

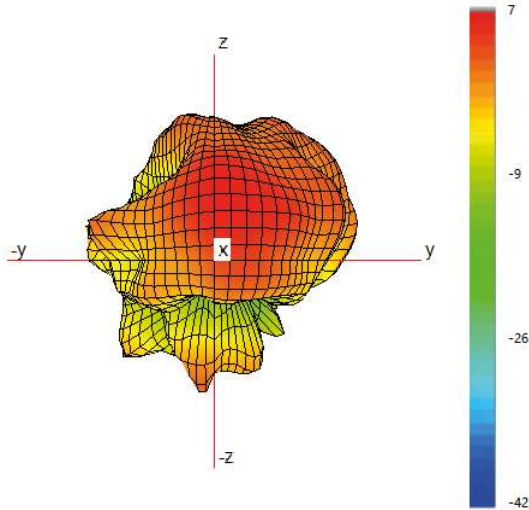

Typical H Plane- WiFi - 3 - Patterns- 2400-2475MHz

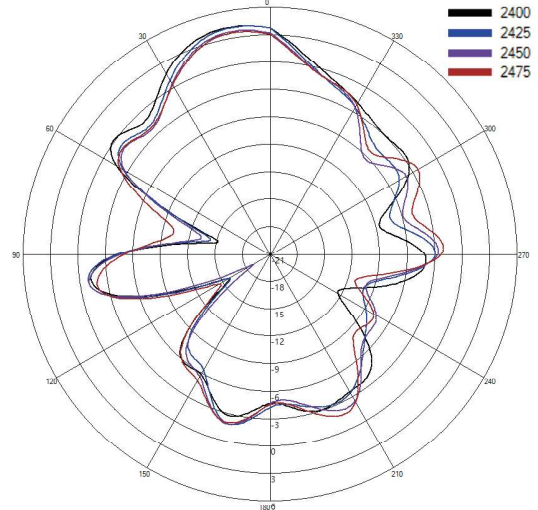

Typical 3D Pattern- WiFi - 3 - 5500 MHz

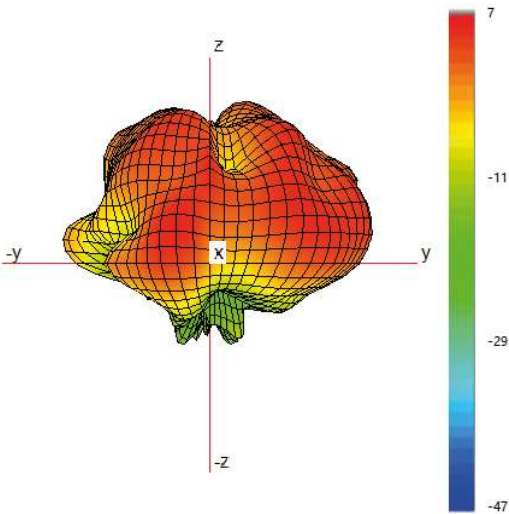

Typical H Plane- WiFi - 3 - Patterns- 5200-5800MHz

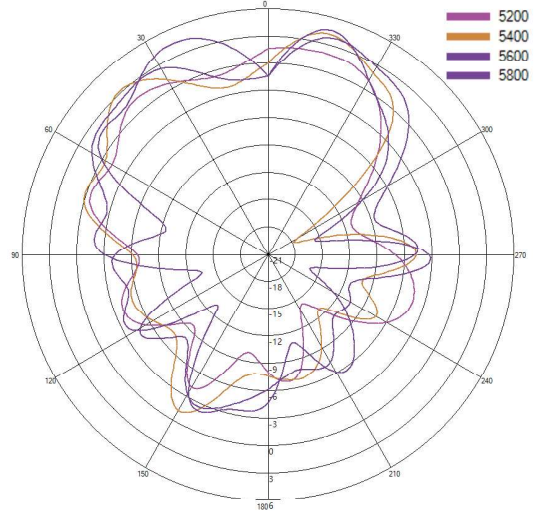

Typical 3D Pattern- WiFi - 3 - 6500 MHz

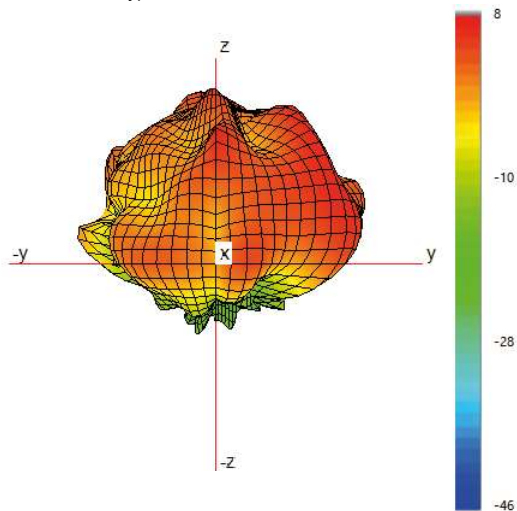

Typical H Plane- WiFi - 3 - Patterns- 6200-6800MHz

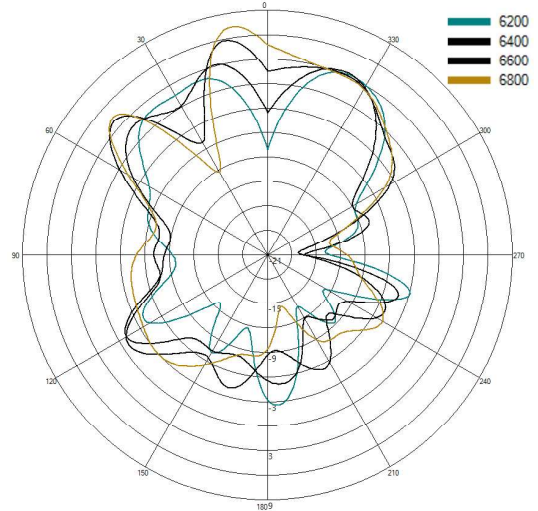

Typical 3D Pattern- WiFi - 4 - 2450 MHz

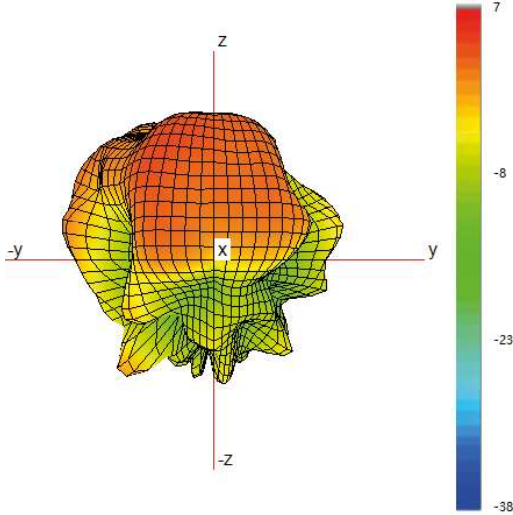

Typical H Plane- WiFi - 4 - Patterns- 2400-2475MHz

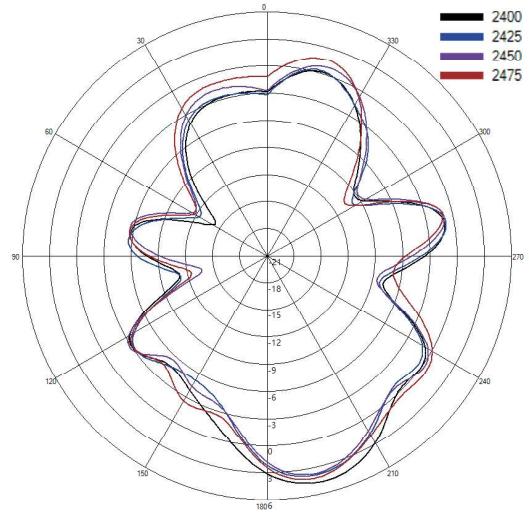

Typical 3D Pattern- WiFi - 4 - 5500 MHz

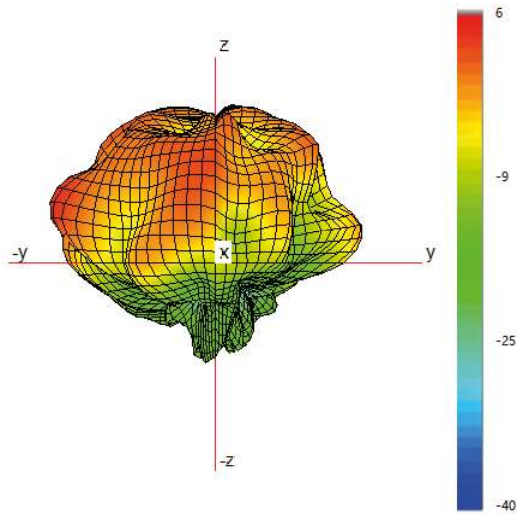

Typical H Plane- WiFi - 4 - Patterns- 5200-5800MHz

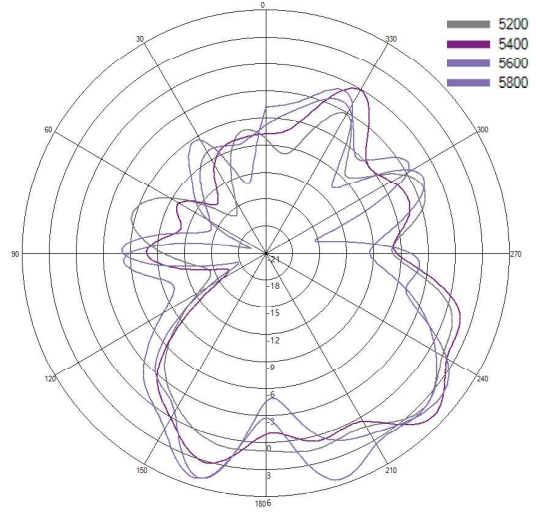

Typical 3D Pattern- WiFi - 4 - 6500 MHz

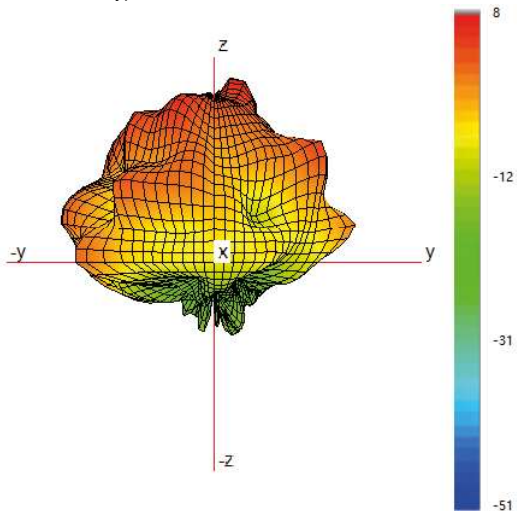

Typical H Plane- WiFi - 4 - Patterns- 6200-6800MHz

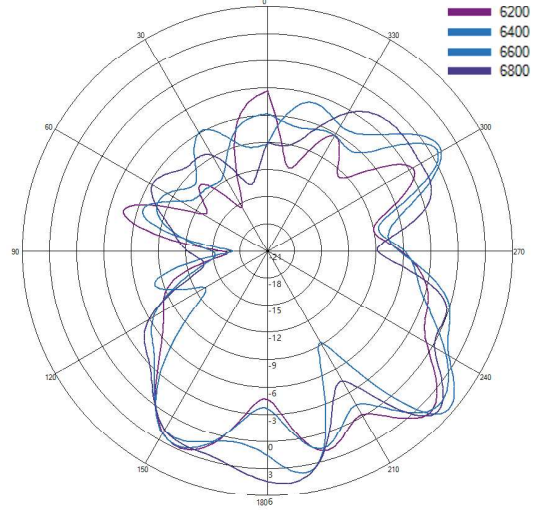

# 4X4 MiMo 4G/5G

## Transit Antenna

TRNM[X]4-6-60-[X]

### E-Plane Patterns- GPS/GNSS

GPS 1575MHz Typical E Plane

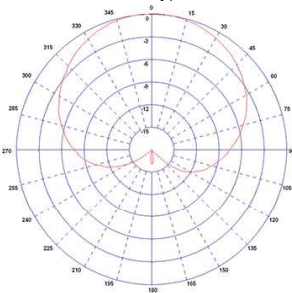

GPS 1602MHz Typical E Plane

