

## ANTENNAS | RIPPLE SERIES

# X-POLARISED, OMNI-DIRECTIONAL 5G/LTE MULTI MIMO ANTENNA ARRAY

617 – 6000 MHz, 6dBi; Cellular 2x (4x4 MIMO); Wi-Fi 4x4 MIMO; 1 x GNSS



- High performance, omni-directional marine & coastal antenna
- Up to 8 x 8 MIMO cellular capability for improved performance
- Covers contemporary 5G/LTE band from 617 to 6000 MHz
- Innovative heat sink design for improved temperature regulation
- UV and saltwater protected for marine and coastal conditions
- IP 69K weather/dust resistant enclosure



APPLICATION AREAS

## Product Overview

Poynting Antennas proudly introduces the SWIRL antenna solution, designed for both maritime and mobility applications. The SWIRL series includes two versatile models: the SWIRL-8 and the SWIRL-4. The SWIRL-8 features 8x cross-polarised cellular antennas, covering frequencies from 617 to 6000 MHz with a peak gain of 6dBi, 4x dual-band Wi-Fi antennas (2.4 GHz and 5 to 7.2 GHz), and 1x dual-band GNSS antenna for L1 and L5 constellations. The SWIRL-4 offers 4x cross-polarised cellular antennas, 4x dual-band Wi-Fi antennas, and 1x dual-band GNSS antenna.

Both models boast a compact design with dimensions of 382 mm in diameter and 127 mm in height, and they come with IK08 and IP69K ratings, ensuring durability in harsh environments. While the SWIRL is primarily aimed at maritime applications, it is also suitable for various mobility applications, making it a versatile choice for diverse connectivity needs.

Additionally, the SWIRL can be transformed into a Customer Premises Equipment (CPE) device by incorporating the SWIRL-BASE. This cast aluminium base is specifically designed to house 5G routers, available in sizes of 231 x 193 x 50 mm or 293.5 x 148.5 x 50 mm. Installing the router within the base reduces coaxial cable runs, thereby improving performance by minimizing signal loss.

Experience the future of connectivity with Poynting's SWIRL antenna solution, engineered for seamless integration and superior performance in demanding environments.

## Features

- Wide Frequency Range: Cellular antennas (617 to 6000 MHz) and dual-band Wi-Fi (2.4 GHz and 5 to 7.2 GHz).
- High Gain Performance with a peak gain of 6dBi for robust signal strength.
- Durable Construction: IK08 and IP69K ratings for protection against impacts and environmental factors.
- CPE Transformation: Compatible with SWIRL-BASE for integrating 5G routers, enhancing performance with short coaxial cable run

## Application Areas

- Reliable connectivity for ships, boats, and other marine vessels.
- Enhanced network performance for vehicles and other mobile platforms.
- Stable connections for remote sites and infrastructure monitoring.
- Robust communication systems for emergency response and public safety services.
- Efficient data transmission for various Internet of Things (IoT) applications in challenging environments.

### Frequency Bands

The SWIRL is an omni-directional antenna array that operates in the following frequency bands: | 617 – 960 MHz | 1427 – 1517 MHz | 1710 – 2700 MHz | 3400 – 4200 MHz | 5000 – 6000 MHz | and the following Wi-Fi frequency bands | 2400 – 2500 MHz | and | 5000 – 7200 MHz |

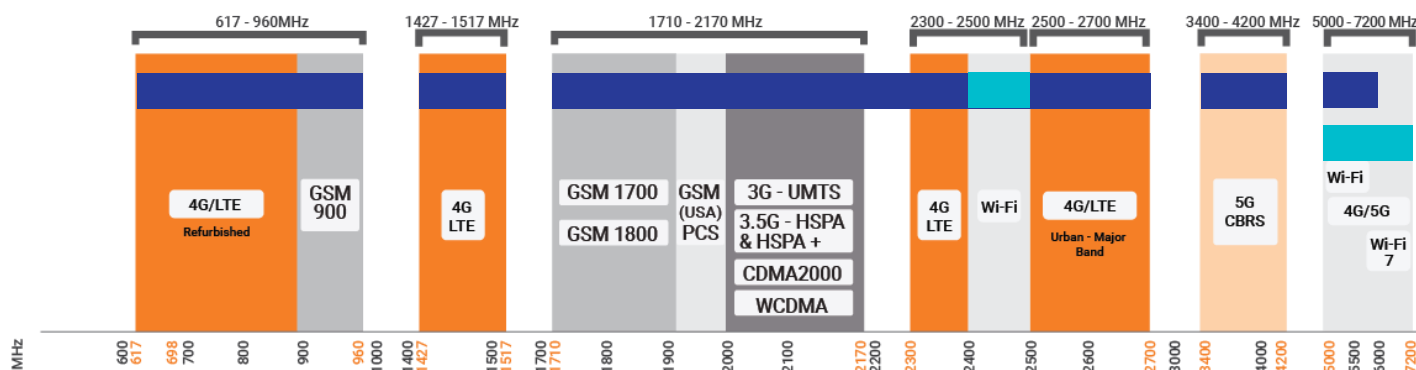

Indicates the 5G/LTE bands on which SWIRL works  Indicates the WI-FI bands on which SWIRL works

### Antenna Derivatives

Product Order Code (SKU)	A-SWIRL-0004-V1-01	A-SWIRL-0004-V1-02	A-SWIRL-0008-V1-01	A-SWIRL-0008-V1-02
Integrated Base	No	Yes	No	Yes
Ports	5G- Vertical Polarised (x 2), 5G- Horizontal Polarised (x 2) Wi-Fi- Vertical Polarised (x 2), Wi-Fi- Horizontal Polarised (x 2) GNSS (x 1)	5G- Vertical Polarised (x 2), 5G- Horizontal Polarised (x 2) Wi-Fi- Vertical Polarised (x 2), Wi-Fi- Horizontal Polarised (x 2) GNSS (x 1)	5G- Vertical Polarised (x 4), 5G- Horizontal Polarised (x 4) Wi-Fi- Vertical Polarised (x 2), Wi-Fi- Horizontal Polarised (x 2) GNSS (x 1)	5G- Vertical Polarised (x 4), 5G- Horizontal Polarised (x 4) Wi-Fi- Vertical Polarised (x 2), Wi-Fi- Horizontal Polarised (x 2) GNSS (x 1)
SISO / MIMO	4x4 MIMO- 5G 4x4 MIMO – Wi-Fi	4x4 MIMO- 5G 4x4 MIMO – Wi-Fi	8x8 MIMO- 5G 4x4 MIMO – Wi-Fi	8x8 MIMO- 5G 4x4 MIMO – Wi-Fi
Frequency Bands	617 - 6000 MHz	617 - 6000 MHz	617 - 6000 MHz	617 - 6000 MHz
Polarisation	Vertical & Horizontal	Vertical & Horizontal	Vertical & Horizontal	Vertical & Horizontal
Peak Gain	6dBi	6dBi	6dBi	6dBi
Connector Type	9 x SMA (male)	9 x SMA (male)	13 x SMA (male)	13 x SMA (male)
Coax Cable Type	9 x RG 316 with SMA (male)	9 x RG 316 with SMA (male)	13 x RG 316 with SMA (male)	13 x RG 316 with SMA (male)
Coax Cable Length	650 mm – 5G, Wi-Fi & GPS	650 mm – 5G, Wi-Fi & GPS	650 mm – 5G, Wi-Fi & GPS	650 mm – 5G, Wi-Fi & GPS
Product Dimensions	Ø382 x 127 mm	Ø382 x 224 mm	Ø382 x 127 mm	Ø382 x 224 mm
Packaged Dimension	440 x 430 x 190 mm	520 x 420 x 270 mm	440 x 430 x 190 mm	520 x 420 x 270 mm
Weight	TBC	TBC	2.83 Kg	8.1 Kg
Packaged Weight	TBC	TBC	4.5 Kg	9.26 Kg
EAN	6009710928578	6009710928899	6009710928639	6009710928875

\*The coax cables & connectors are factory mounted to the antenna

## Electrical Specifications - Cellular

Frequency Bands:	617 – 960 MHz 1427 – 1517 MHz 1710 – 2700 MHz 3400 – 4200 MHz 5000 – 6000 MHz
Gain Vertical:	4 dBi @ 617 – 960 MHz 4 dBi @ 1427 – 1517 MHz 6 dBi @ 1710 – 2700 MHz 5.5 dBi @ 3400 – 4200 MHz 4 dBi @ 5000 – 6000 MHz
Gain Horizontal:	2 dBi @ 617 – 960 MHz 2 dBi @ 1427 – 1517 MHz 4 dBi @ 1710 – 2700 MHz 2 dBi @ 3400 – 4200 MHz 4 dBi @ 5000 – 7200 MHz
VSWR Vertical:	≤2.5:1
VSWR Horizontal:	≤2.5:1
Feed Power Handling:	10 W
Input Impedance:	50 Ohm (nominal)
DC Short:	Yes

## Electrical Specifications - GNSS

Frequency Range (GPS):	GPS L5: 1176 MHz ± 20 MHz GPS L1: 1575 MHz ± 20 MHz
LNA Gain:	28 ± 3 dBi
VSWR:	≤2
DC Voltage:	3.3 – 5 V
DC Current:	<20 mA
Nominal Impedance:	50 Ω
Polarisation:	RHCP
Out of Band Rejection:	30dBc min
Power Capacity:	33dBm
Coax Cable Loss:	0.71 dB/m @ 1500 MHz

## Electrical Specifications - Wi-Fi

Frequency:	2400 - 2500 MHz 5000 – 7200 MHz
Gain (Max):	5 dBi @ 2400 - 2500 MHz 8.5 dBi @ 5000 - 7200 MHz
VSWR:	≤ 2.5:1 over 90% of the band
Feed Power Handling:	10 W
Nominal Input Impedance:	50 Ohm (nominal)
Coax Cable Loss:	0.91 dB/m @ 2400 MHz 1.65 dB/m @ 5800 MHz
Path to Ground:	Yes

## Mechanical Specifications

Radome Material:	UV Stable E-Glass
Radome Colour:	Brilliant White Pantone P 179-1 C
Mounting Type:	Surface mount

## Environmental Specifications, Certification & Approvals

Wind Survival:	≤186 km/h
Temperature Range (Operating):	-40°C to +80°C
Environmental Conditions:	Outdoor/Indoor
Water ingress protection ratio/standard:	IP69K
Salt Spray:	MIL-STD 810G/ASTM B117
Operating Relative Humidity:	Up to 98%
Storage Humidity:	5% to 95% - non-condensing
Storage Temperature:	-40°C to +80°C
Enclosure Flammability Rating:	UL 94-HB
Impact resistance:	IK 08
Product Safety & Environmental:	Complies with CE and RoHS standards



**Antenna Performance Plots**

**VSWR: Cellular Vertical**

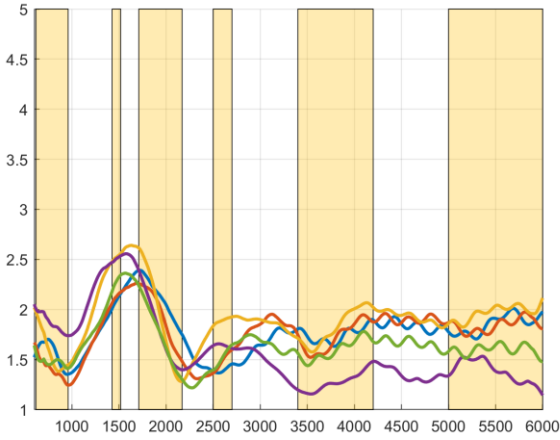

**Voltage Standing Wave Ratio (VSWR)\***

VSWR is a measure of how efficiently radio-frequency power is transmitted from a power source, through a transmission line, into a load. In an ideal system, 100% of the energy is transmitted which corresponds to a VSWR of 1:1.

The SWIRL delivers superior performance across all bands with a VSWR of  $\leq 2.5:1$ .

\*VSWR measured with a 650mm low loss cable

**GAIN (EXCLUDING CABLE LOSS): Cellular Vertical**

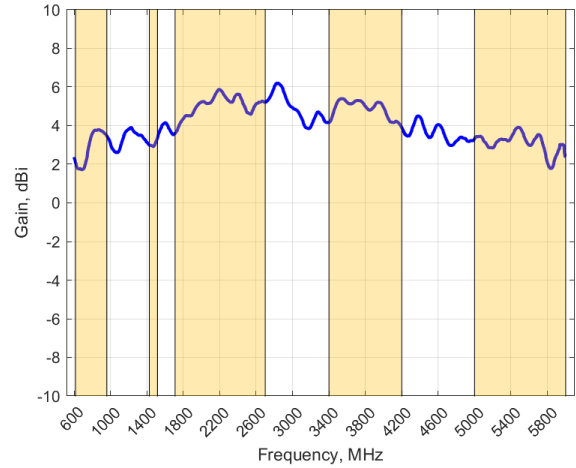

**Gain\* in dBi**

6 dBi is the peak gain across all bands from 617 – 6000 MHz

Gain @ 617 – 960 MHz:	4 dBi
Gain @ 1427 – 1517 MHz:	4 dBi
Gain @ 1710 – 2700 MHz:	6 dBi
Gain @ 3400 – 4200 MHz:	5.5 dBi
Gain @ 5000 – 6000 MHz:	4 dBi

\*Antenna gain measured with polarisation aligned standard antenna

**VSWR: Cellular Horizontal**

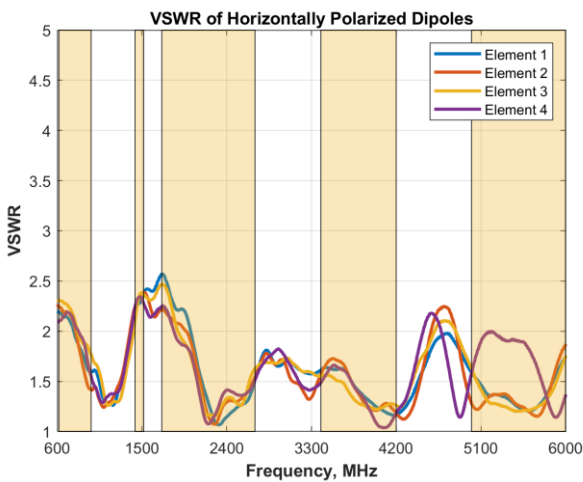

**Voltage Standing Wave Ratio (VSWR)\***

VSWR is a measure of how efficiently radio-frequency power is transmitted from a power source, through a transmission line, into a load. In an ideal system, 100% of the energy is transmitted which corresponds to a VSWR of 1:1.

The SWIRL delivers superior performance across all bands with a VSWR of 2.5:1 or better.

\*VSWR measured with a 650mm low loss cable

**GAIN (EXCLUDING CABLE LOSS): Cellular Horizontal**

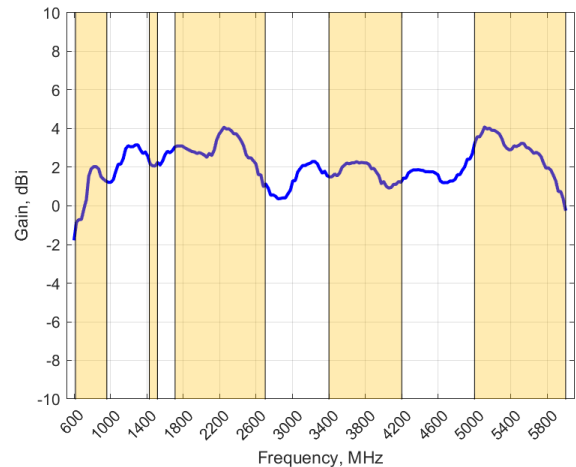

**Gain\* in dBi**

4 dBi is the peak gain across all bands from 617 – 6000 MHz

Gain @ 617 – 960 MHz:	2 dBi
Gain @ 1427 – 1517 MHz:	2 dBi
Gain @ 1710 – 2700 MHz:	4 dBi
Gain @ 3400 – 4200 MHz:	2 dBi
Gain @ 5000 – 6000 MHz:	4 dBi

\*Antenna gain measured with polarisation aligned standard antenna

**VSWR: WI-FI**

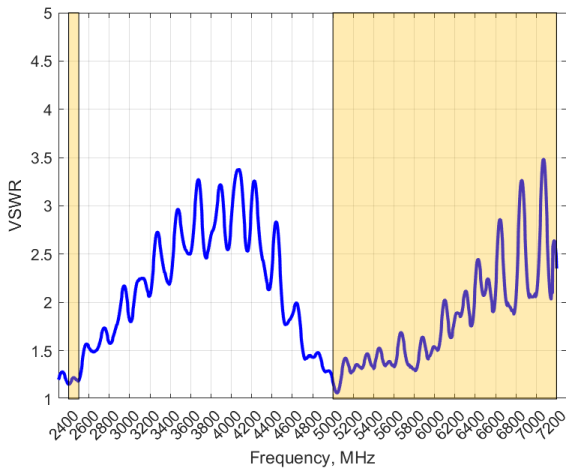

**Voltage Standing Wave Ratio (VSWR)\***

VSWR is a measure of how efficiently radio-frequency power is transmitted from a power source, through a transmission line, into a load. In an ideal system, 100% of the energy is transmitted which corresponds to a VSWR of 1:1.

The SWIRL delivers superior performance across all bands with a VSWR of  $\leq 2.5:1$  across 90% of the bands.

\*VSWR measured with a 650mm low loss cable.

**GAIN (EXCLUDING CABLE LOSS): WI-FI**

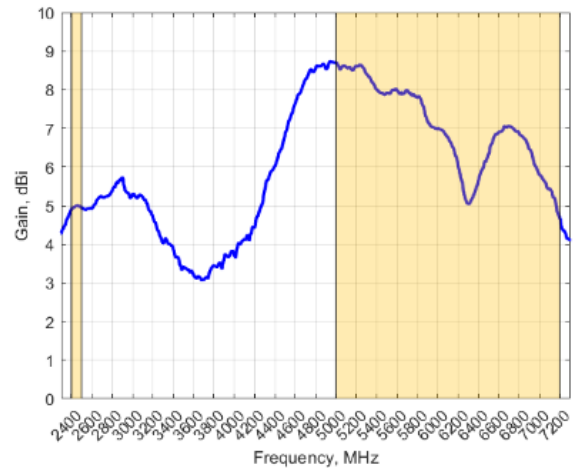

**Gain\* in dBi**

8.5 dBi is the peak gain across all bands from 2400 – 7200 MHz

Gain @ 2400 – 2500 MHz:	5 dBi
Gain @ 5000 – 7200 MHz:	8.5 dBi

\*Antenna gain measured with polarisation aligned standard antenna

Technical Drawings

SWIRL Antenna Solution

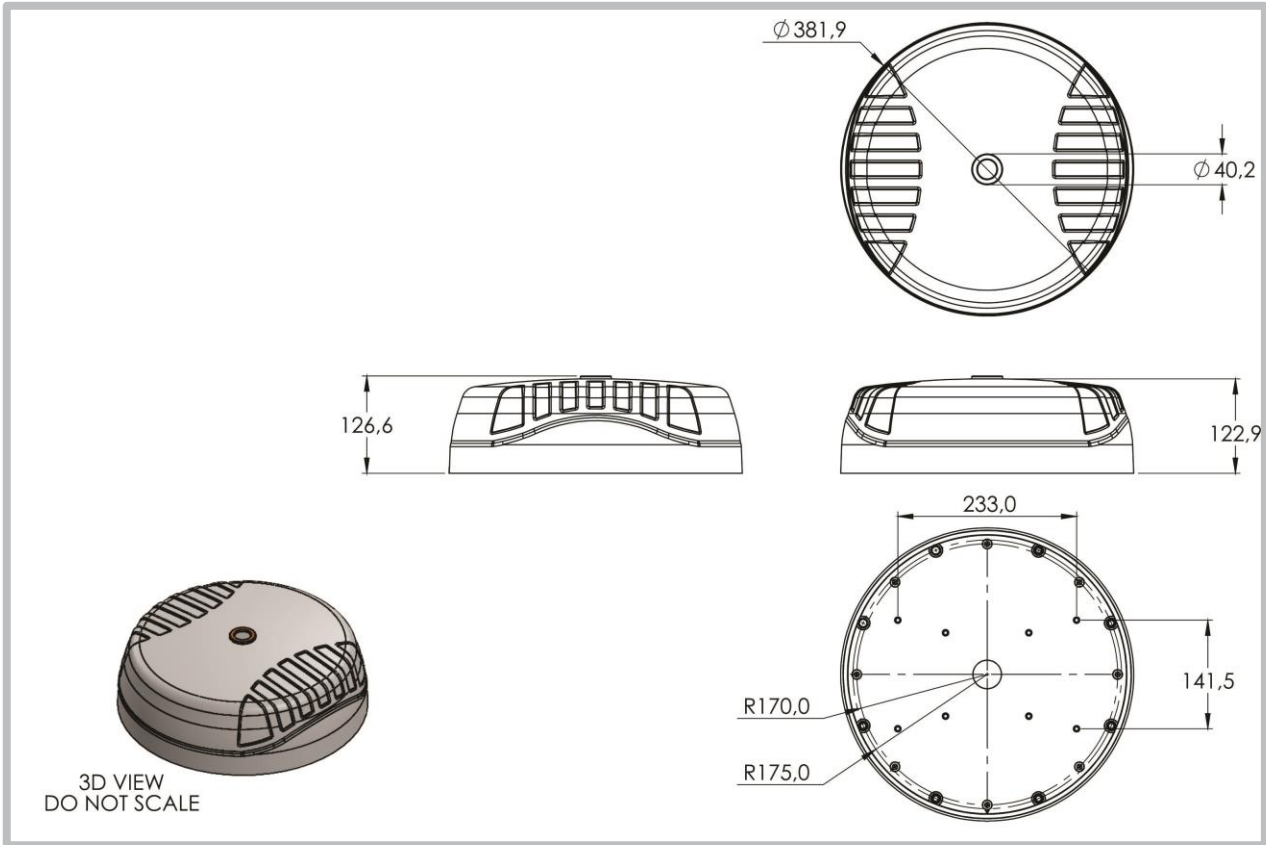

SWIRL Base

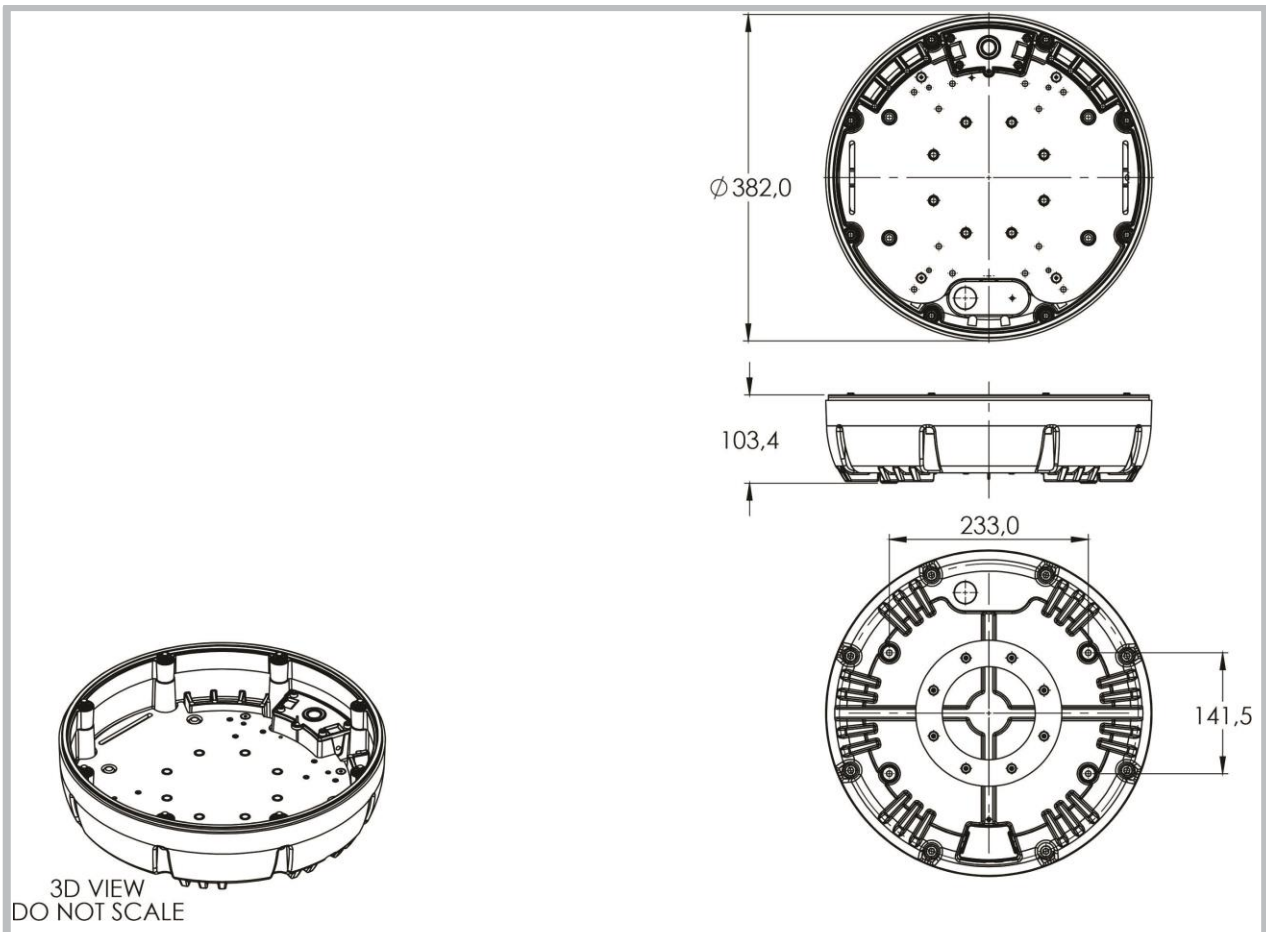

SWIRL Antenna and Base Solution

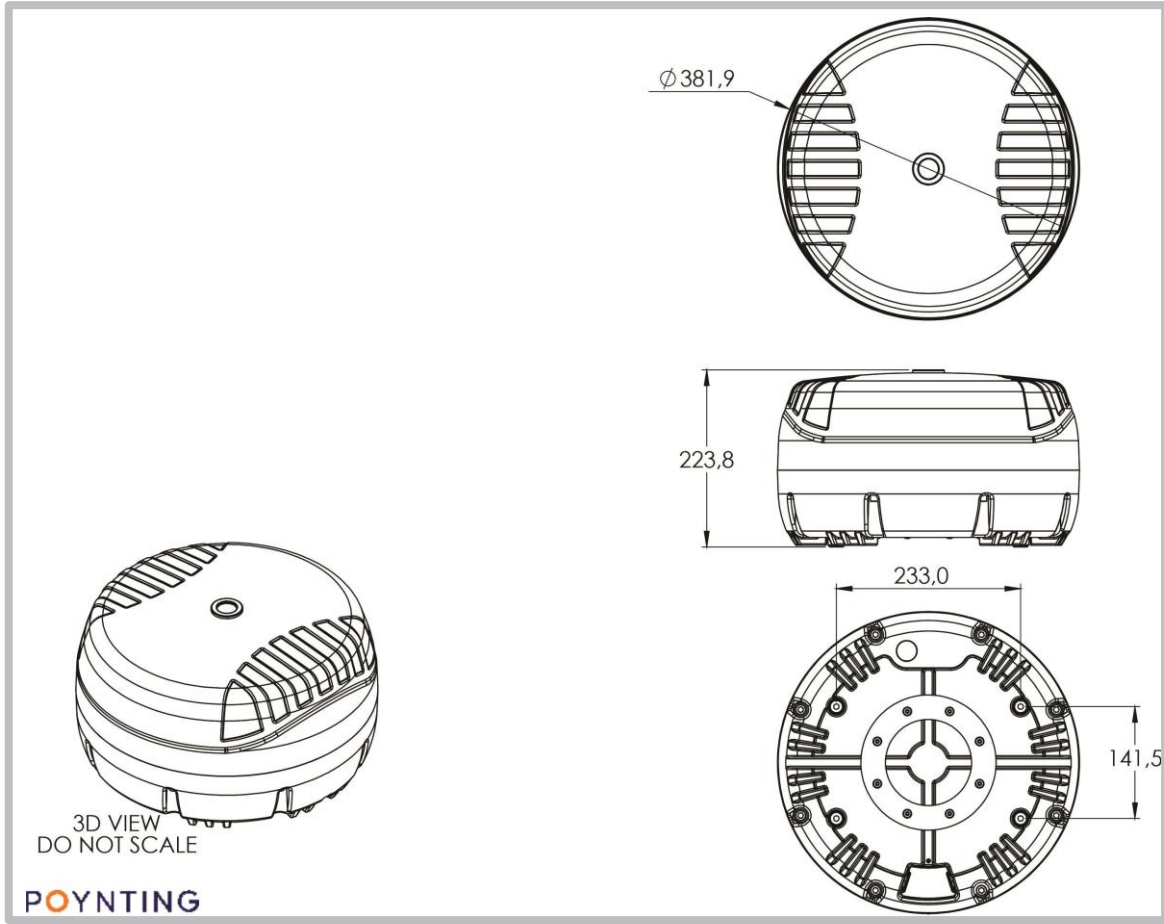

SWIRL Base Available Router Space (Horizontal)

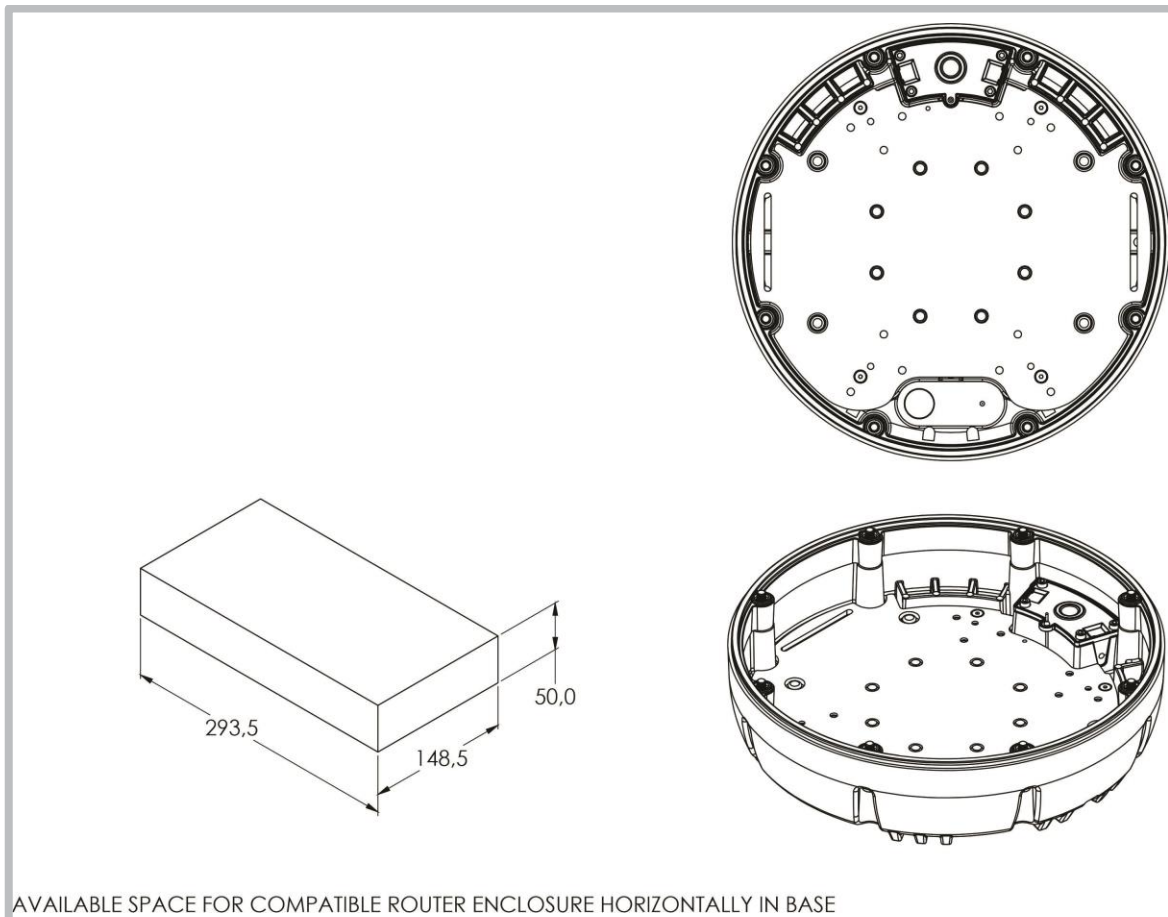

AVAILABLE SPACE FOR COMPATIBLE ROUTER ENCLOSURE HORIZONTALLY IN BASE

SWIRL Base Available Router Space (Vertical)

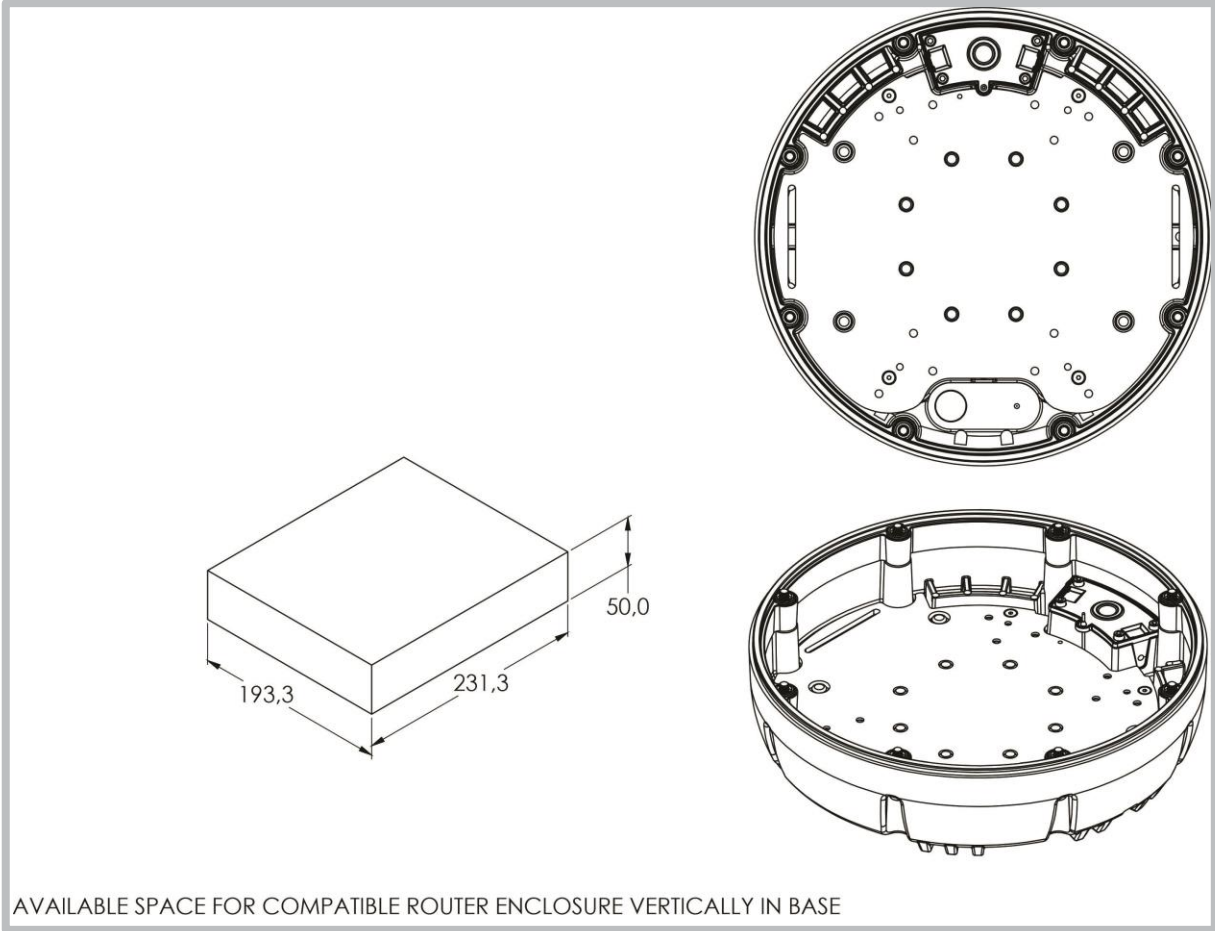

AVAILABLE SPACE FOR COMPATIBLE ROUTER ENCLOSURE VERTICALLY IN BASE

SWIRL Base Router Hole Configurations

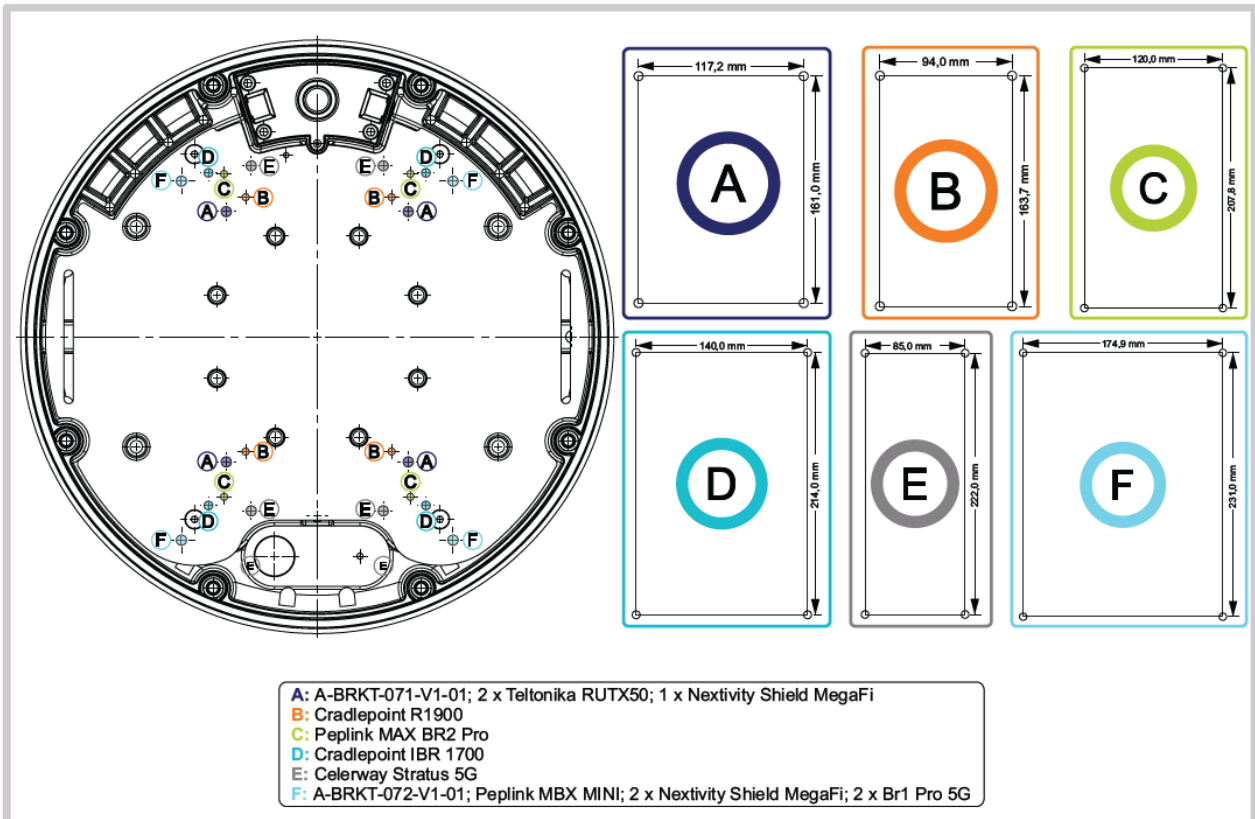



**Radiation Patterns - Cellular Vertical**

**Azimuth: 617 - 960 MHz**

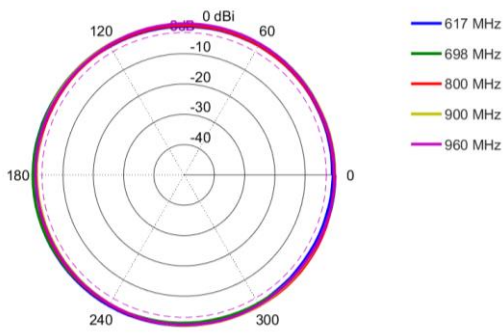

**Elevation: 617 - 960 MHz**

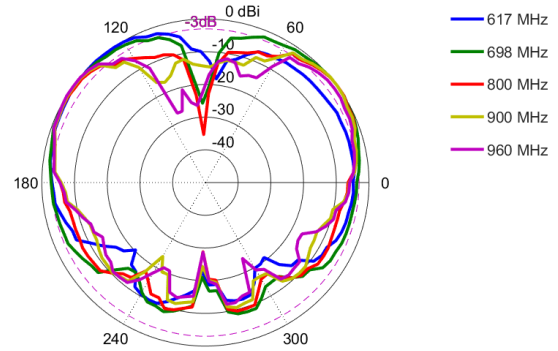

**Azimuth: 1427 - 1517 MHz**

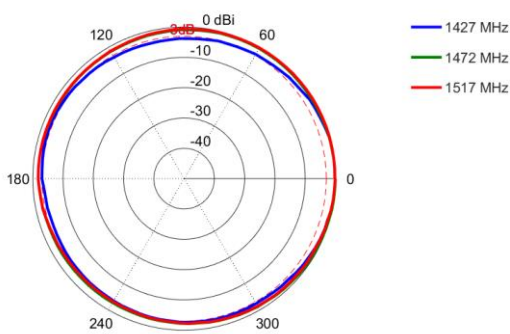

**Elevation: 1427 - 1517 MHz**

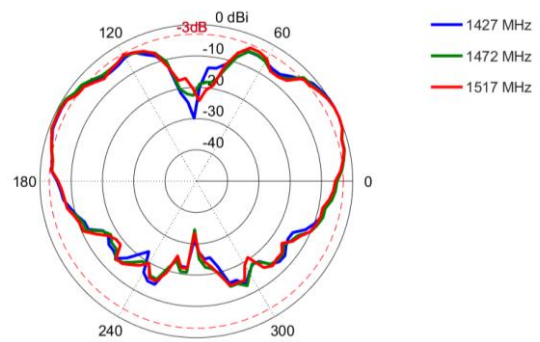

**Azimuth: 1710 - 2170 MHz**

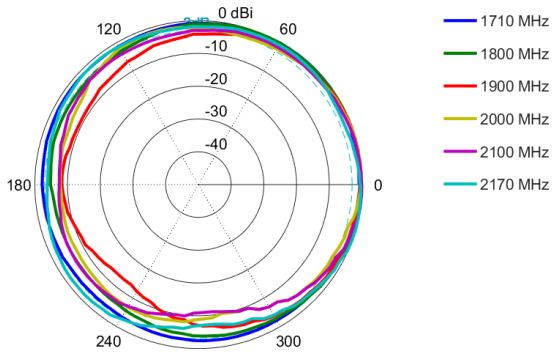

**Elevation: 1710 - 2170 MHz**

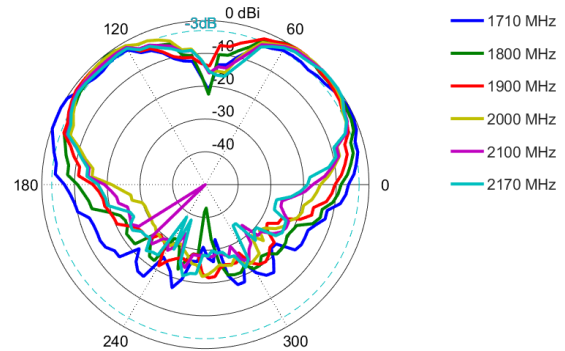

**Azimuth: 2300 - 2700 MHz**

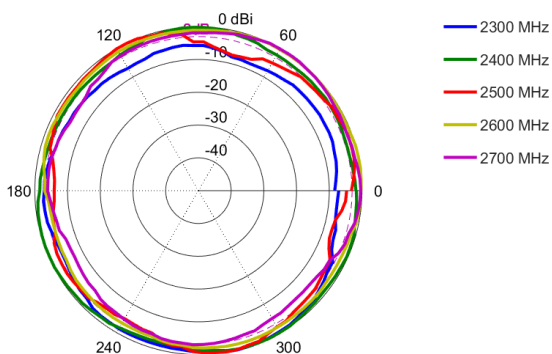

**Azimuth: 2300 - 2700 MHz**

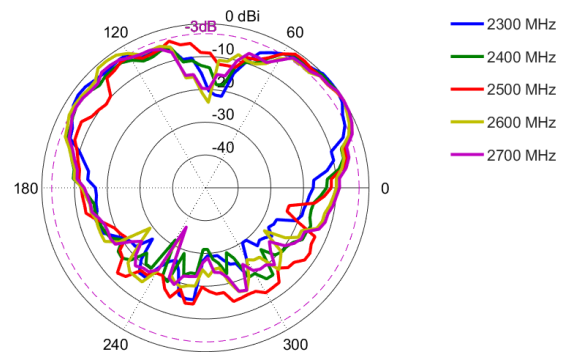

**Azimuth: 3400 – 4200 MHz**

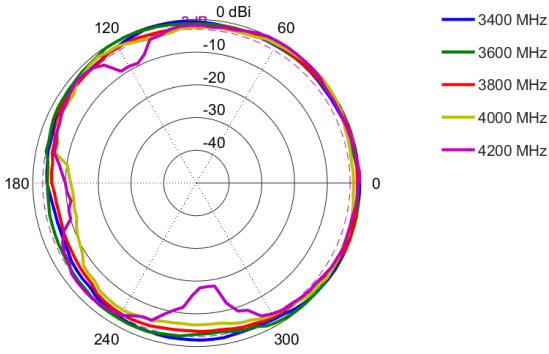

**Elevation: 3400 – 4200 MHz**

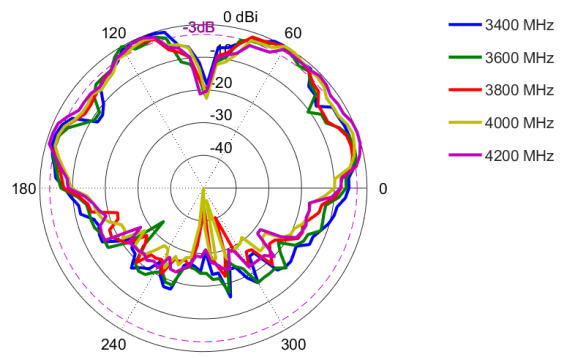

**Azimuth: 5000 – 6000 MHz**

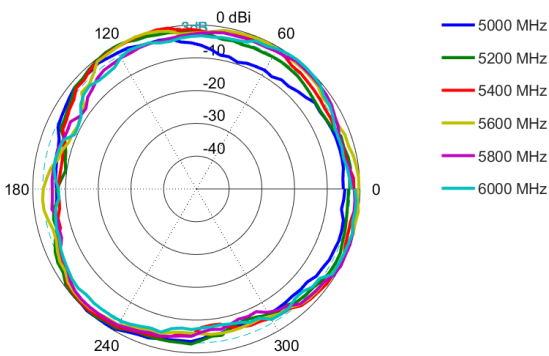

**Elevation: 5000 – 6000 MHz**

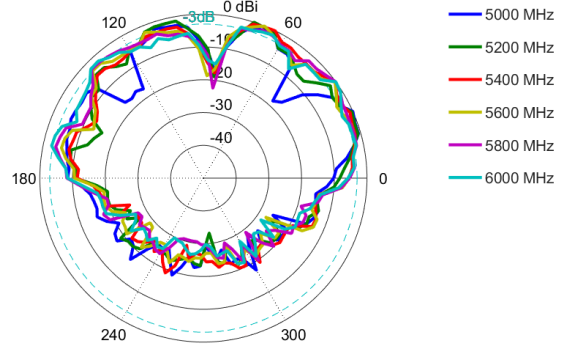

**Radiation Patterns - Cellular Horizontal**

**Azimuth: 617 – 960 MHz**

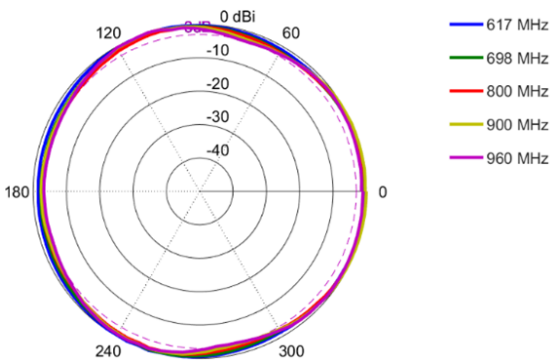

**Elevation: 617 – 960 MHz**

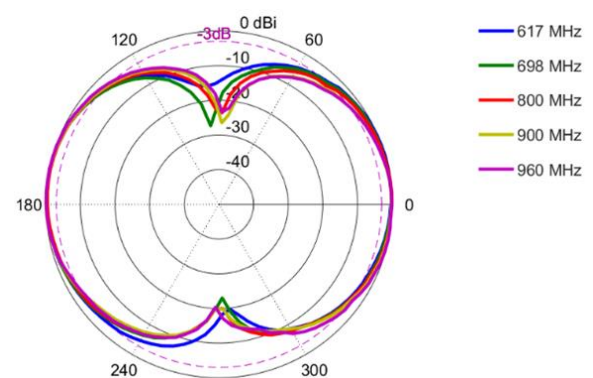

**Azimuth: 1427 – 1517 MHz**

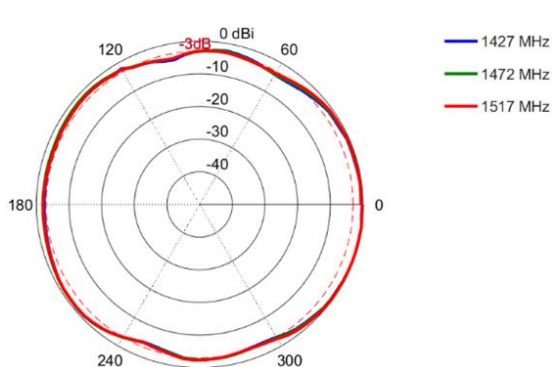

**Elevation: 1427 – 1517 MHz**

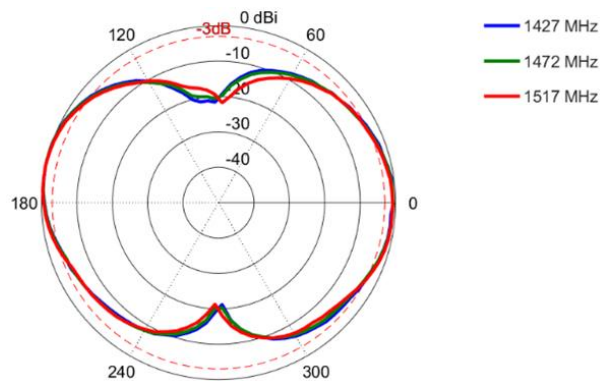

**Azimuth: 1710 – 2170 MHz**

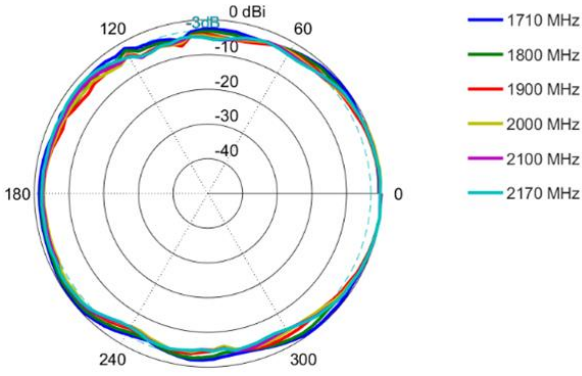

**Elevation: 1710 – 2170 MHz**

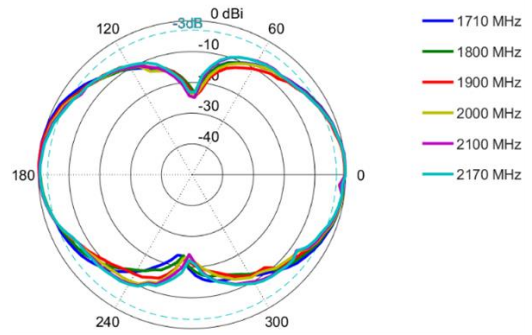

**Azimuth: 2300 – 2700 MHz**

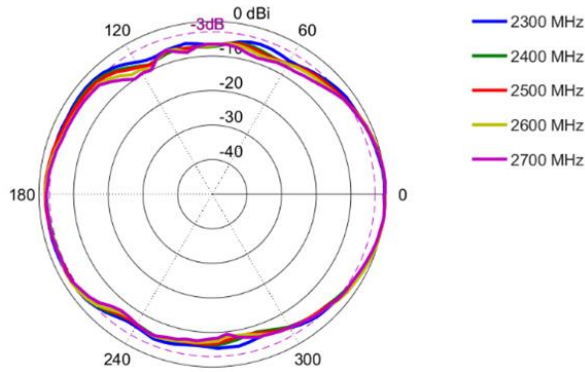

**Elevation: 2300 – 2700 MHz**

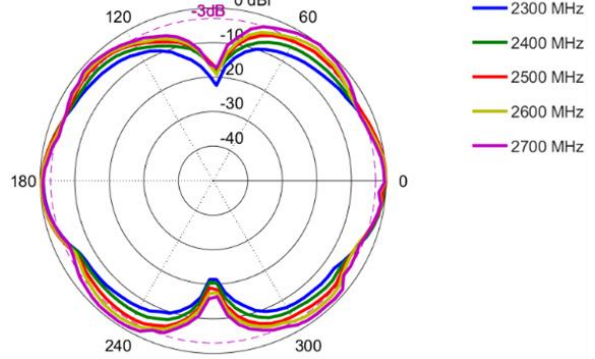

**Azimuth: 3400 – 4200 MHz**

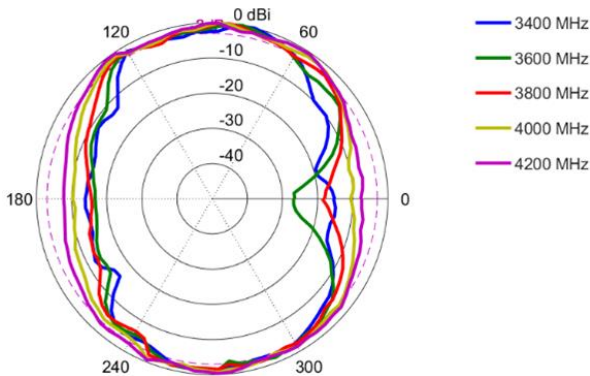

**Elevation: 3400 – 4200 MHz**

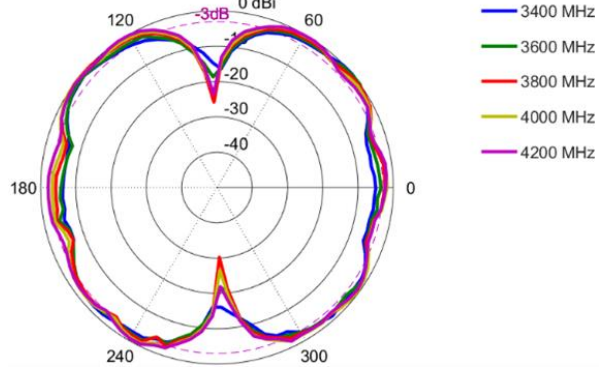

**Azimuth: 5000 – 6000 MHz**

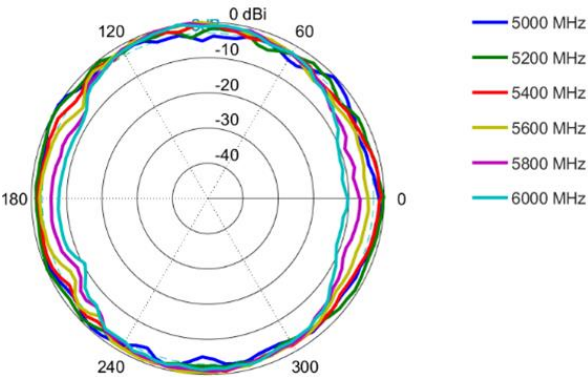

**Elevation: 5000 – 6000 MHz**

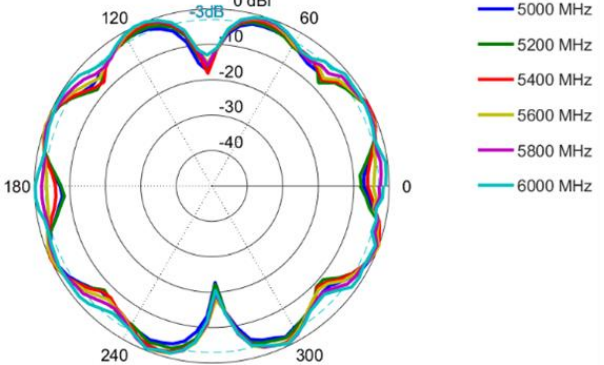

**Radiation Patterns - WI-FI**

**Azimuth: 2400 – 2500 MHz**

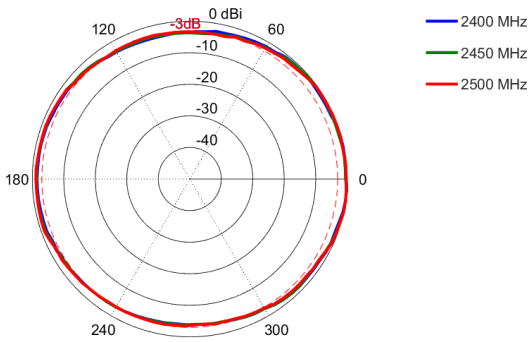

**Elevation: 2400 – 2500 MHz**

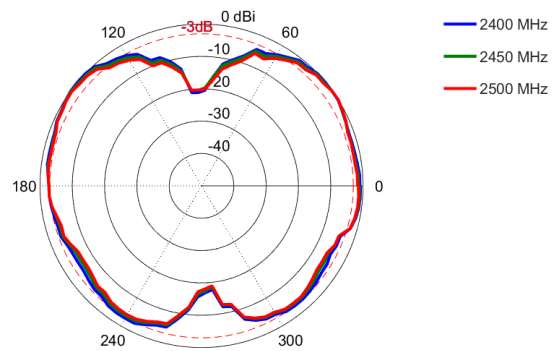

**Azimuth: 5000 – 6000 MHz**

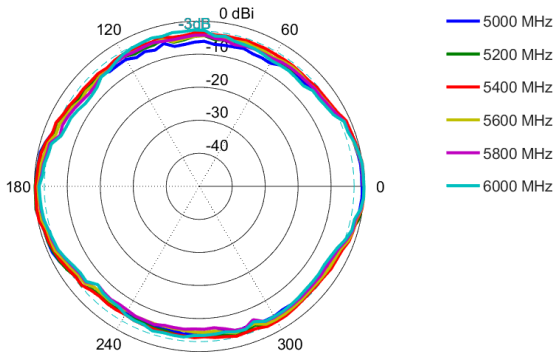

**Elevation: 5000 – 6000 MHz**

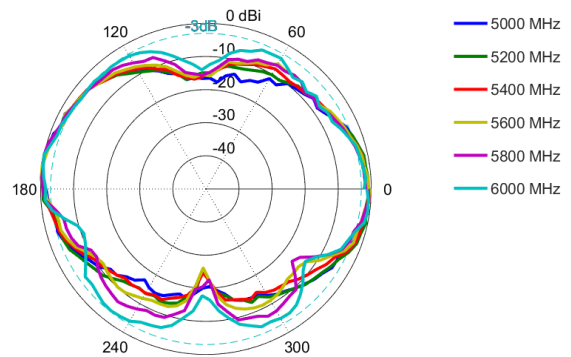

**Azimuth: 6000 – 7200 MHz**

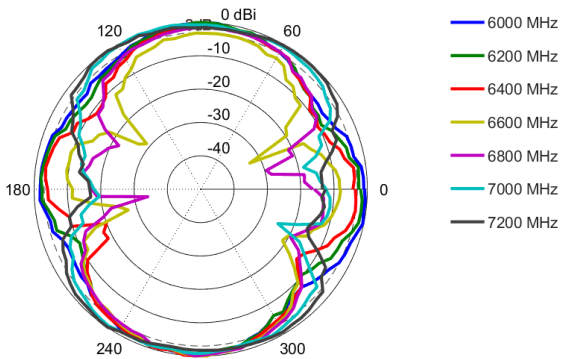

**Elevation: 6000 – 7200 MHz**

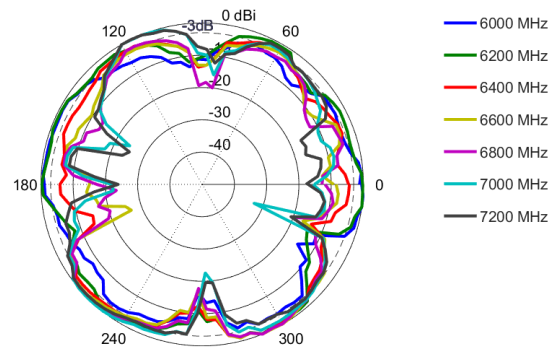

## Mounting Options



### Surface Mount

Adhesive surface mounting (included) to directly secure the antenna to a surface.



### Magnet mount

Magnetic Base Kit (MBK-4 not included)  
For temporary and low-mobility installations.

## Additional Accessories

### A-SWIRL-BASE-V1-01

Optional base accessory solution to transform your SWIRL into a CPE-ready solution.



See accessories technical specifications on [www.poynting.tech](http://www.poynting.tech)

## CONTACT POYNTING

### Poynting Antennas (Pty) Ltd - Head Office

Unit 4, N1 Industrial Park,  
Landmarks Avenue,  
Samrand, 0157, South Africa

**Phone:** +27 (0) 12 657 0050

**E-mail:** [info@poynting.tech](mailto:info@poynting.tech)

**International Email:** [sales-global@poynting.tech](mailto:sales-global@poynting.tech)

### Poynting Europe

Regus Business Center Neue Messe Riem  
Kronstadter Straße 4  
81677 München  
Germany

**Phone:** +49 89 7453 9002

**E-mail:** [sales-europe@poynting.tech](mailto:sales-europe@poynting.tech)

### Poynting USA

1804 Owen Court, Suite 104,  
Mansfield,  
TX 76063  
USA

**Phone:** +1 817 533-8130

**E-mail:** [sales-us@poynting.tech](mailto:sales-us@poynting.tech)