

Kindermann KDC AV-kalustesarja

Tarjoaa täydellisen integraation AV- ja dataliitinrunkoihin. Sarja perustuu kahden puolilevyn yhdistämiseen, mahdollistaen yksilöllisen AV-asennusrungon rakentamisen. Helppo koota ja asentaa, yhteensopiva yleisimpiin sähkökalusteisiin ja saatavilla kahdessa värissä: RAL 9010 valkoinen ja RAL 7024 antrasiitti.



RAL 9010 valkoinen



RAL 7024 antrasiitti



KDC-asennusrungon mukana tulee kolme etulevyä. Asennettavissa eri sähkökalusteisiin etulevyt: 50x50 mm, 54x54 mm, 55x55 mm.

**Quality
made
in
Germany**
by Kindermann

KDC-asennusesimerkki sähkökalusteeseen

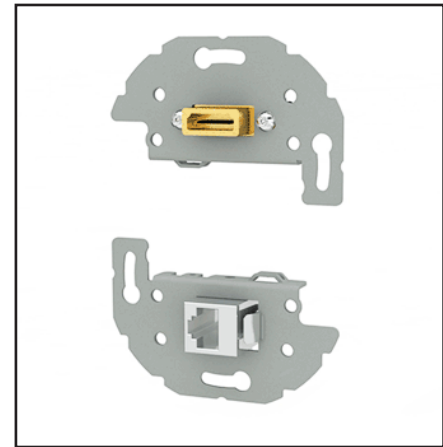
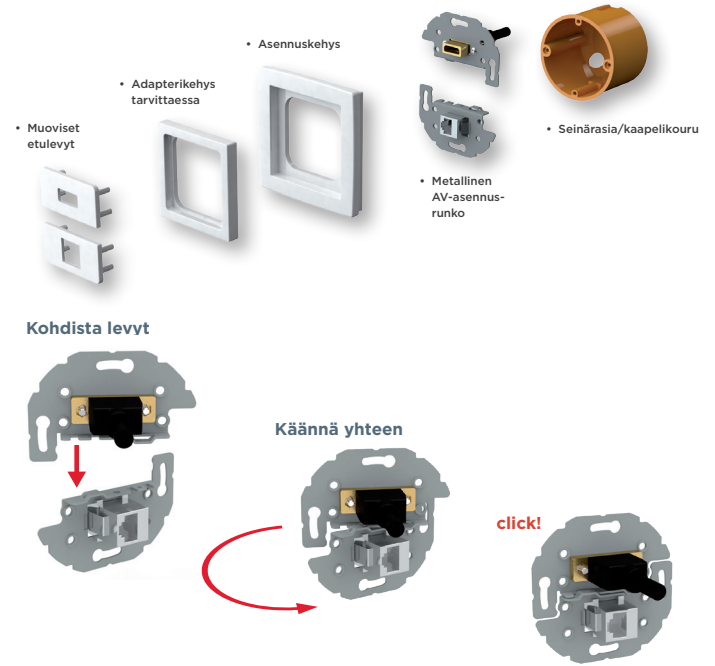

KDC on yhteensopiva seuraavien sähkökalusteiden kanssa:

ABB

55x55 mm	Jussi
55x55 mm	85 mm Impressivo
55x55 mm	100 mm Impressivo Tarvitsee sovittimen Sovitin 85/100 valkoinen sn. 2166116 Sovitin 85/100 antrasiitti sn. 2166118 Sovitin 85/100 alumiini sn. 2166220
55x55 mm	Saga

Schneider-Electric

55x55 mm	Exxact
55x55 mm	Elco

Berker, Busch, Elso, Gira, Peha, Jung, Hager, Kopp, Legrand, Merten ja Siemens

7456 000 400 **7935100** valkoinen
7457 000 400 **7935160** antrasiitti

sokealevy 1/2

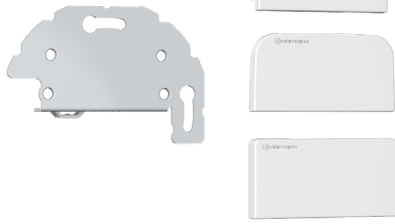

7456 000 582 **7935142** valkoinen
7457 000 582 **7935161** antrasiitti

HDMI naaras 90° 20 cm kaapelilla
asennussyvyys 25 mm

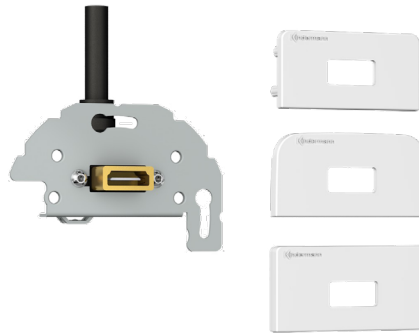

7456 000 502 **7935113**

DVI-I naaras
20 cm kaapelilla
1/1 levyä
asennussyvyys 65 mm



7456 000 412B **7935199** valkoinen
7457 000 412B antrasiitti

D-aukko levy
Levyn sopivat kaikki
D-aukkoiset runkolittimet

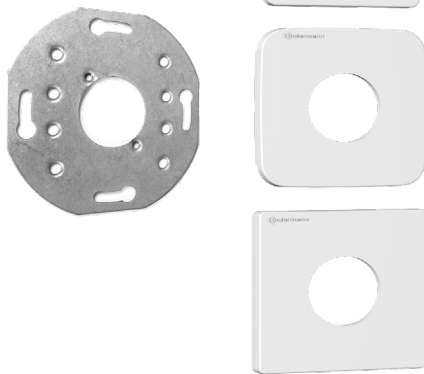

7456 000 543 **7935133** lähetin
7457 000 544 **7935134** vastaanotin

HDMI HDBaseT 4K@70 m PoC 2 x täysikokoinen levy
7488000027 virtalähde 24 VDC / 0,5A



7456 000 510 **7935118** 20 cm kaapelilla

7457 000 510 **7935164** valkoinen

7456 000 410 **7935102** 20 cm kaapelilla

valkoinen
20 cm kaapelilla
antrasiitti
juotettava
valkoinen

Audio 2 x RCA naaras
asennussyvyys:
kaapelilla 47 mm
juotettava 30 mm



7456 000 444 **7935198**

Ø 5 mm kaapeliauukko
1/2 levy

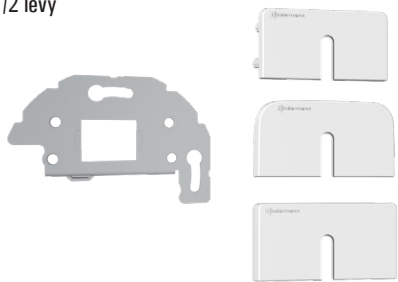

7456 000 583 **7935144** valkoinen
7457 000 583 **7935162** antrasiitti

DisplayPort 90°
naaras/naaras adapteri
asennussyvyys 20 mm



7456 000 511 **7935119** 20 cm kaapelilla

7456 000 411 **7935103** valkoinen

7457 000 511 **7935165** 20 cm kaapelilla

7457 000 411 **7935174** 20 cm kaapelilla

valkoinen
juotettava
valkoinen
20 cm kaapelilla
antrasiitti
juotettava
antrasiitti

7456 000 542 **7935132** valkoinen
7457 000 542 **0000000** antrasiitti

HDMI-naaras/HDMI-naaras
asennussyvyys kaapelilla 52 mm
20 cm kaapelilla

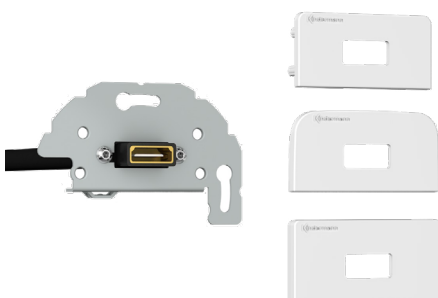

7456 000 588 **7935144** valkoinen
7457 000 588 **7935144** antrasiitti

DisplayPort
naaras/naaras 20 cm kaapelilla
asennussyvyys 55 mm



Audio 3,5 mm naaras asennussyvyys:
kaapelilla 47 mm
juotettava 30 mm



7456 000 414 **7935106** valkoinen
7457 000 414 **7935169** antrasiitti

Naparuuvi x 2 juotettava + ruuv
asennussyvyys 37 mm
4 mm² kaapeli

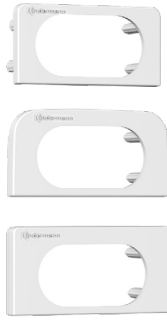
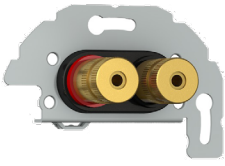

7456 000 416 **7935107** valkoinen
7457 000 416 **7935163** antrasiitti

XLR 3-nap uros juotettava
asennussyvyys 40 mm



7456 000 522 **7935122**

USB2.0 A-naaras/A-naaras
20 cm kaapelilla
asennussyvyys 42 mm

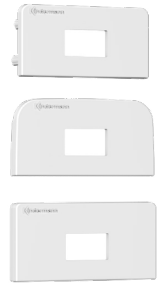
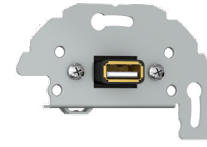

7456 000 413 **7935105**

Speakon 4-nap
naaras juotettava
asennussyvyys 40 mm
maksimi kuorma 40 A



naaras/naaras adapteri
7456 000 523 **7935123** valkoinen
7457 000 523 **7935167** antrasiitti

naaras/naaras adapteri (BTR)
7456 000 526 **7935126** valkoinen
7457 000 526 **7935170** antrasiitti

20 cm kaapelilla
7456 000 527 **7935127** valkoinen
7457 000 527 **7935168** antrasiitti

7456 000 423 **7935109** valkoinen
puristettava liitin

Cat6a (RJ45)
asennussyvyys:
kaapelilla 52 mm
puristettava 52 mm

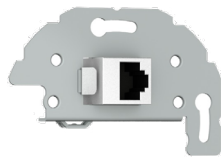

7456 000 525 **7935125** valkoinen
7457 000 525 **7935171** antrasiitti

USB2.0 B-naaras/A-naaras 20 cm kaapelilla USB A
-naaras asennussyvyys 42 mm

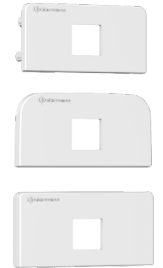
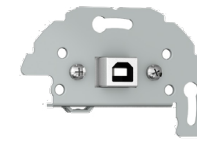

7456 000 412 **7935104** valkoinen
7457 000 412 **7935169** antrasiitti

XLR 3-nap naaras juotettava
asennussyvyys 40 mm



7456 000 529 **7935157** valkoinen
7457 000 529 **7935172** antrasiitti

USB3.0 A-naaras/A-naaras 20 cm kaapelilla
asennussyvyys 42 mm

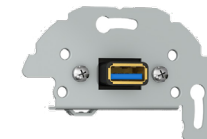

7456 000 520 **7935121** valkoinen
7457 000 520 **7935166** antrasiitti

RS232 (9-nap D-liitin)
20 cm kaapelilla
asennussyvyys 42 mm

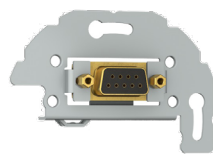

7456 000 549 **7935159** valkoinen
7457 000 549 **7935173** antrasiitti

USB C-naaras/C-naaras
asennussyvyys 42 mm



HDMI 2.0 AOC Kinderman kuitukaapeli
HDMI A naaras/HDMI D-uros

Valkoinen

7456000705	5 m
7456000708	8 m
7456000710	10 m
7456000715	15 m
7456000720	20 m
7456000725	25 m



Antrasiitti

7457000705	5 m
7457000708	8 m
7457000710	10 m
7457000715	15 m
7457000720	20 m
7457000725	25 m



7487000701

HDMI -adapteri
 A-uros/D-naaras
 suora



7487000703

HDMI -adapteri
 A-uros/D-naaras
 kulma vasen



7487000702

HDMI -adapteri
 A-uros/D-naaras
 kulma oikea



Asennusesimerkki AOC kaapelilla. Kiinteä HDMI-siirtotie 5-25 m

Sokea levy
 7456 000 400

HDMI kuitukaapeli integroidulla KDC sarjan runkoliittimellä

HDMI levy
 7456 000 582 kulma
 7456 000 542 suora



7487000701
 HDMI -adapteri
 A-uros/D-naaras suora

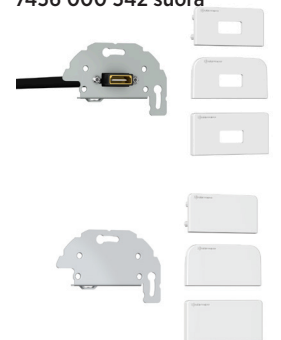

Sokea levy
 7456 000 400

Asennusesimerkki:

Opettajan tai neuvotteluhuoneen pöydälle on asennettu CPD² AV-kaluste. Kalusteessa Cat/RJ45, HDMI, Displayport, USB-lataus, 3,5 mm audio ja suko. Syöttö tykille, näytölle ja aktiivikaiuttimille.

Cableport KF45 levyt:

HDMI	7464 000 842
DisplayPort	7464 000 588
3,5 mm	7464 000 811
USB 2.0	7464 000 822
Virtakaapeli 3 m	7444 000 303

- Audiosiirto C118 / C121 diodikaapelilla, balansoidulla OT234H audiokaapelilla tai väljohdolla CR70467 - CR70474
- HDMI-siirto Clicktronicin CR70300 - CR70310 väljohdolla tai Purelinkin FX-I350 (4K) ja FX-I380 (8K) sarjoilla
- USB-siirto esim. Atenin UCE260 CAT/USB-muuntimella

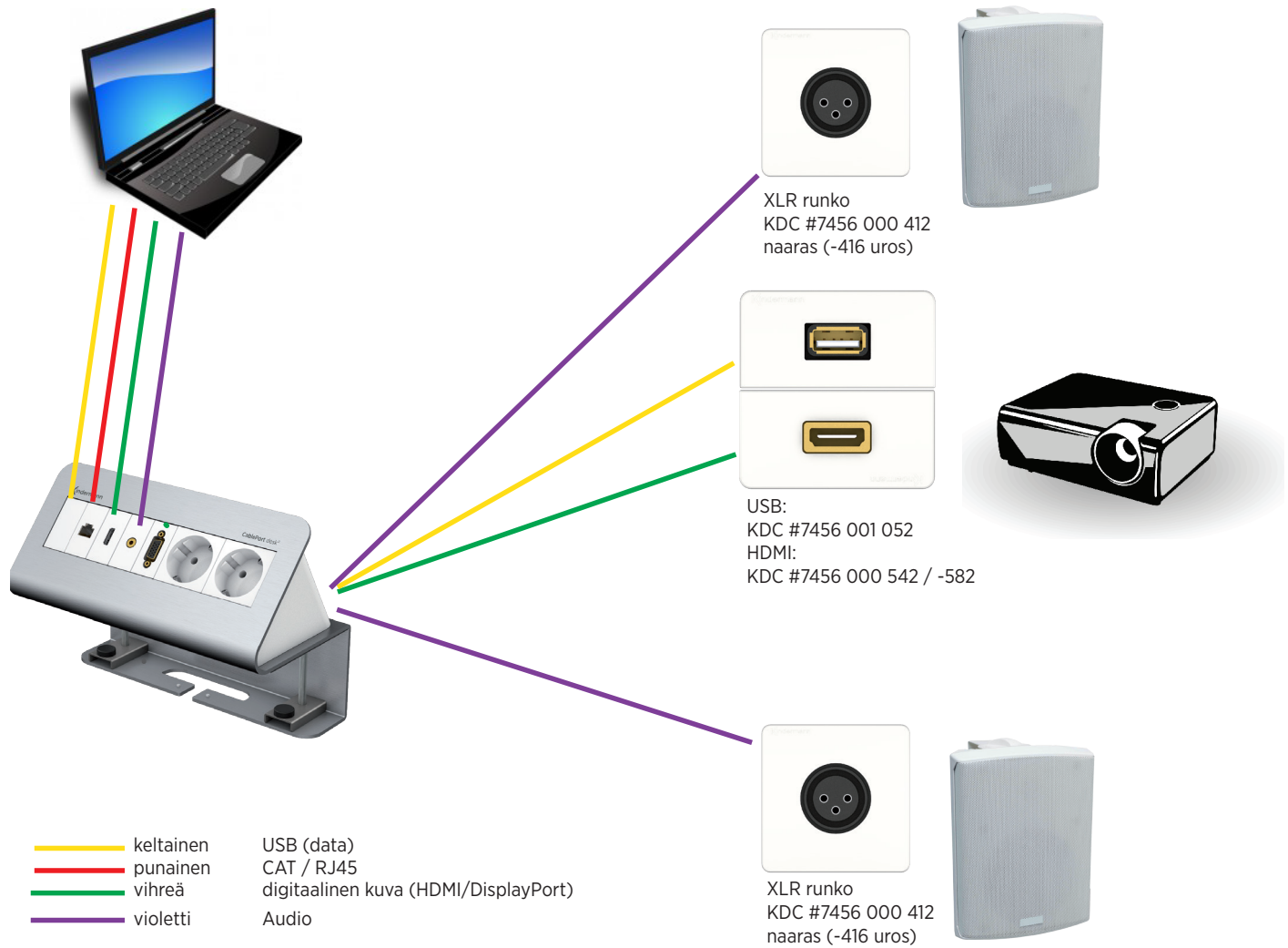

Asennusesimerkkejä:

USB-SIIRTO

- Lyhyet, alle 5 m siirrot hyvälaatuisella USB-kaapelilla (esim. TK13.. pituuden mukaan)
- 5-12 m siirrot voidaan tehdä USB-vahvistinkaapelilla (esim. ATEN UE2120 / UE250)
- 12-60 m siirrot USB/CAT-muuntimella (esim. ATEN UCE260)
- Moduilit KDC tai KF45

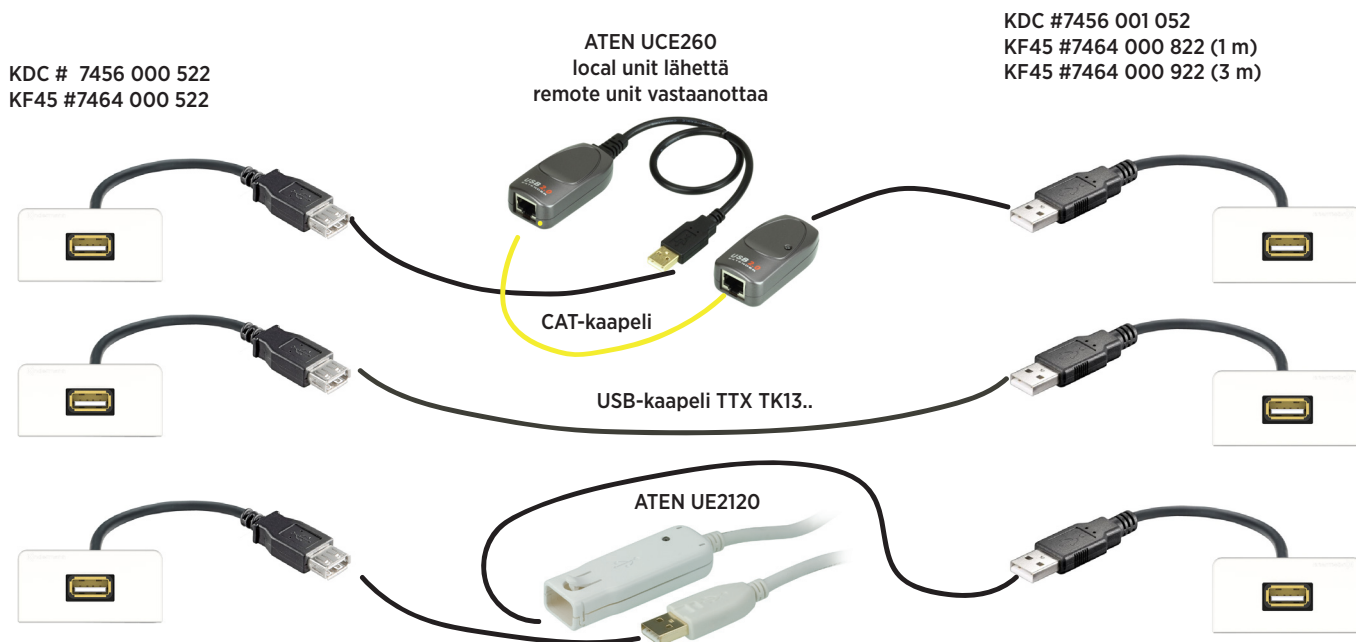

Asennusesimerkkejä:

Aktiivikaiuttimet

- Siirto tehdään hyvälaatuisella diodikaapelilla (C118 / C121) juottamalla.
- Lähtö 2 x RCA naaras tai 3,5 mm stereo runko

RCA runko
KDC #7456 000 410 (-510 20 cm adapteri kaapeli)
KF45 # 7464 000 510 (vain adapteri kaapeli)

XLR runko
KDC #7456 000 412 naaras (-416 uros)
KF45 # 7464 000 412 (vain naaras)

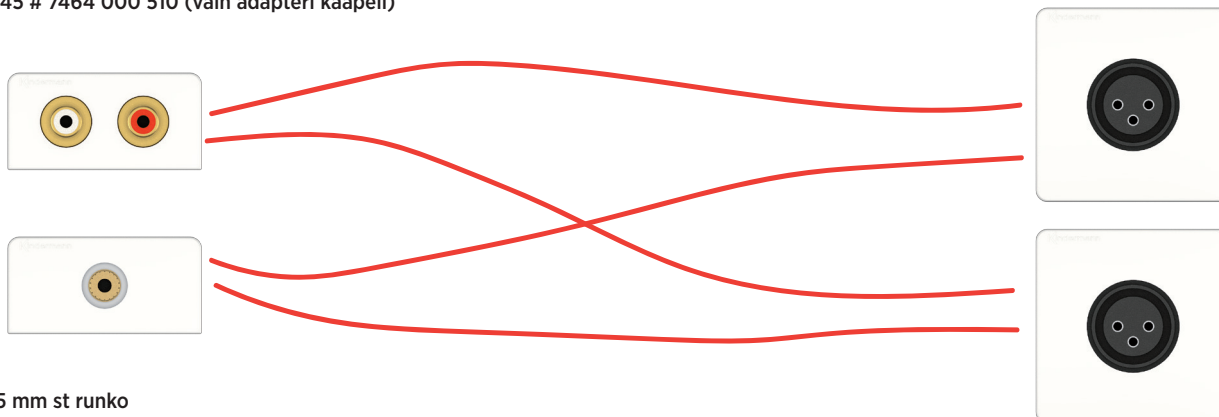

3,5 mm st runko
KDC #7456 000 411 (-511 20 cm adapteri kaapeli)
KF45 # 7464 000 511 (vain adapteri kaapeli)

Konnect flex 45 click (KF45)

Paina suoraan paikoilleen asennuskehykseen

- Helppoa ja nopeaa, hetkessä valmis, ilman työkaluja
- Monipuoliset liitännät
- Edistyksellinen muotoilu, levyissä kynnet asennuskiskoon, ei asennusruuveja
- CablePort standard²:ssa voit vaihtaa adapterilevyjä
- Soveltuu myös asennuskouruihin, minimiasennussyvyys 60 mm

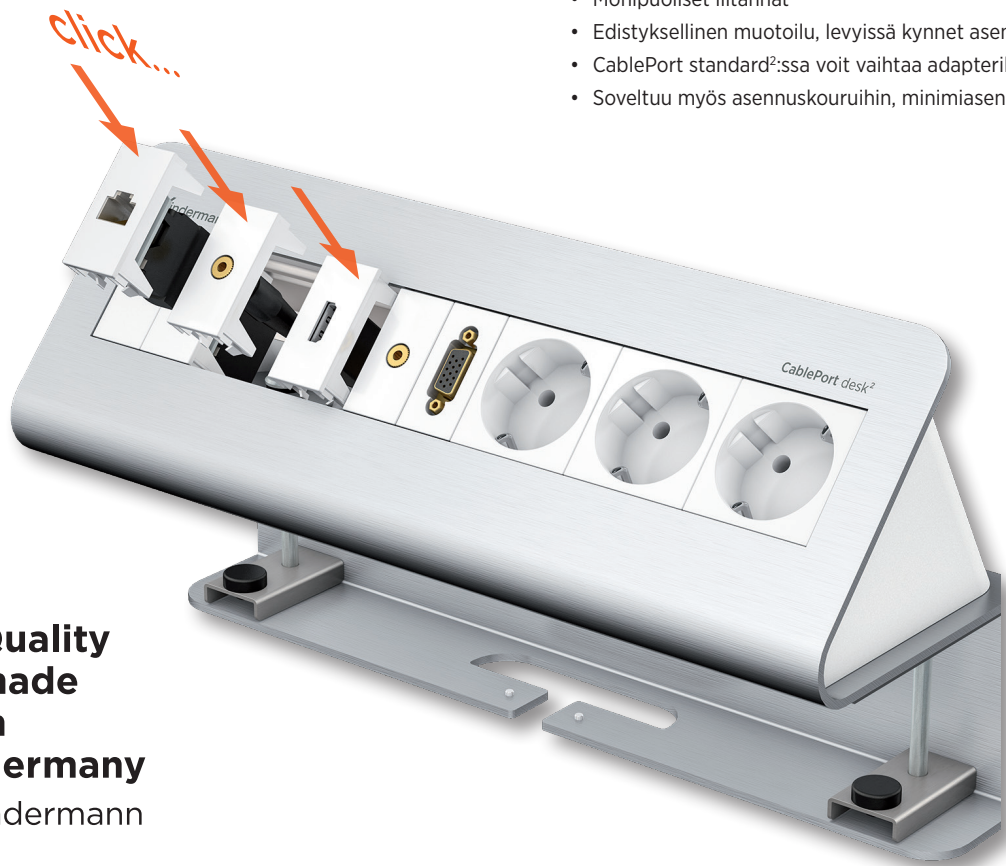

**Quality
made
in
Germany**
by Kindermann

Konnect flex 45 click (KF45)

- naaras/naaras 20 cm



- naaras 19-pin uros (KDA)



- naaras/uross 1 m
- naaras/uross 3 m



7464 000 542 **7918072** 0,2 m kaapeli N/N
 7464 000 842 **7918082** 1 m kaapeli N/U
 7464 000 942 **7918090** 3 m kaapeli N/U

HDMI-levy. Uros/naaras kaapeli. 1/2 koko



7464 000 510 **7918064** 0,2 m kaapeli N/N
 7464 000 910 **7918086** 3 m kaapeli N/U

audio RCA

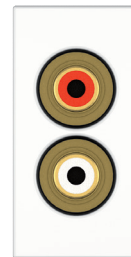

7464 000 561 **7918073** 0,2 m kaapeli N/N

HDMI 19-nap KDA 20 cm kaapeli



7464 000 511 **7918065** 0,2 m kaapeli N/N
 7464 000 811 **7918077** 1 m kaapeli N/U
 7464 000 911 **7918087** 3 m kaapeli N/U

audio 3,5 mm stereo

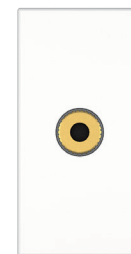

7464 000 502 **7918063** 0,2 m kaapeli N/N

DVI-I Uros/naaras kaapeli. 1/2 koko



7464 000 423 **7918051**
 puristettava CAT6a (RJ45)
 ANSI/TIA 568 C.2 500 MHz
 ISO/IEC 60603-7-51, 11801
 AMD2:2010-04

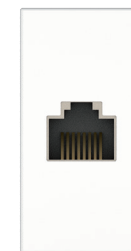

7464 000 588 **7918075** 0,2 m kaapeli
 7464 000 888 **7918083** 1 m kaapeli N/U

Displayport Uros/naaras kaapeli. 1/2 koko



7464 000 424 **7918052**
 puristettava CAT7 (GG45) Nexans
 1 000 MHz

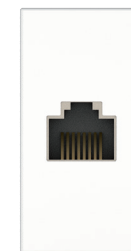

7464 000 501 **7918062** 0,2 m kaapeli N/N
 7464 000 801 **7918076** 1 m kaapeli N/U
 7464 000 901 **7918084** 3 m kaapeli N/U

VGA Uros/naaras kaapeli. 1/2 koko



7464 000 523 **7918067**
 CAT6a (RJ45) n/n adapteri

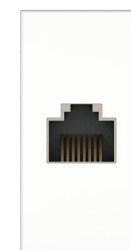

7464 000 412 **7918050**

XLR3-naaras juotettava



7464 000 526 **7918069**
 CAT6a BTR (RJ45) n/n adapteri
 10 GBit Ethernet (IEEE 802.3)
 ISO/IEC 11801 ED2.2.2011-06,
 DIN EN 50173- 1:2011-09

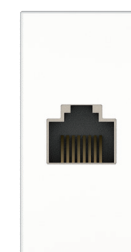

7464 412 020
 Tyhjä Neutrik D-aukon levy

NEW

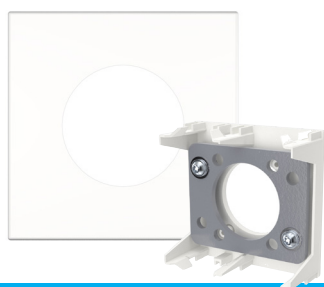

7464 000 400 **7918049** 1/2 koko
 7464 000 500 **7918061** 1/1 koko

sokealevy



7464 000 527 7918070 0,2 m kaapeli N/N
 7464 000 827 7918079 1 m kaapeli N/U
 7464 000 927 7918089 3 m kaapeli N/U

CAT6 (RJ45)

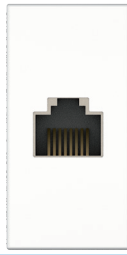

7464 000 587 7918074

CAT6a/Audio 0,2 m kaapeli N/N

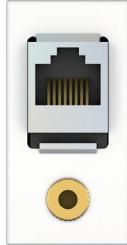

7464 000 558

LC UPC duplex adapteri

NEW



7464 000 522 7918066 0,2 m kaapeli N/N
 7464 000 822 7918078 1 m kaapeli N/U
 7464 000 922 7918088 3 m kaapeli N/U

USB A-naaras/A-naaras



7464 000 525 7918068

USB A-naaras/B-naaras 0,2 m kaapeli N/N



7464 000 529 7918071 0,2 m kaapeli N/N
 7464 000 828 7918080 3 m kaapeli N/U

USB 3.0 A-naaras/A-naaras



7464 000 548 0000000 naaras/uross
 7464 000 549 0000000 naaras/naaras

USB C 0,2 m kaapeli

NEW



7464 000 620 0000000 USB C
 7464 000 621 0000000 Micro USB

Kaapeli kelalla, kaapelin pituus 35-40 cm
 7464 000 620 USB C-uross/USB A-uross
 7464 000 620 USB Micro/USB A-uross

NEW



7464 000 441 7918053
 30 VDC/500 mA painonapilla, juotettava

7464 000 443 7918055
 LED-painonapilla, juotettava 9-12 VDC sininen LED

7464 000 448 7918058
 LED-painonapilla, yhteensopiva Quickselect 2.0 kanssa



7464 000 446 7918056 Ø 8 mm
 7464 000 447 7918057 Ø 12 mm

kaapeliläpivienti



7464 000 452 7918059

kaapelipistorasia



7464 000 451 7918060

D ohjuri, yhteensopiva
 7464 000 450:n kanssa



7449 000 231

4-paik moduuli, KF45-sarjaan
1 x suko, 2 x lataavaa USB 2,5A,
1x vapaa 1/1 paikka



7449 000 332

6-paik moduuli, KF45-sarjaan
2 x suko, 2 x lataavaa USB 2,5A,
3 x vapaa 1/1 paikka



7449 000 022 4 modulille
7449 000 023 6 modulille

Alumiinikehys 7449 000 2xx moduleille



7449 000 024 4 modulille
7449 000 025 6 modulille

Alumiinikehys + liukukansi 7449 000 2xx moduleille



7449 000 040

Kaapelikaivo pinta-asennus Suko, USB A, HDMI ja CAT6 runkoliittimet
Ø 80 mm asennusreikä, 100 mm asennussyvyys



7444 000 303 3 m
7444 000 305 5 m
7444 000 308 8 m

Verkkojohto suko/Wieland, Cableport² kalusteille





reddot award 2015
winner



CablePort desk²

Teknologia yhdistettynä muotoiluun

Nykyaikaiset toimisto- ja konferenssikalusteet varustetaan digitaalista mediaa varten. Niissä on oltava liitännät verkkovirralle, tietoverkoille sekä multimedialle.

CablePort desk² -tuotteet yhdistävät teknologian, toiminnallisuuden ja huippumuotoilun.

Pelkistetty tyyli ja silmää hivelevä, kaartuva metalli aikaansaavat ainutlaatuisen muotoilun. CablePort desk²:n portaaton kiinnitysmekanismi tekee siitä yleiskäyttöisen nykyaikaiseen toimintaympäristöön. Verkkovirta- ja data- sekä AV-kaapelointi voidaan asentaa työpöydälle jälkiä jättämättä.

Muotoilun ansiosta kaapelit on helppo ohjata siististi joko kaapelikouruun tai lattiasiaan.

- Konfiguroitavissa yksilöllisesti KF45-adaptereita käyttäen (7464 000 xxx)
- Saatavilla lisäominaisuuksia, kuten lataavat USB-pistokkeet
- Saatavilla kaksi kokoa, max. 4 tai 6 virtapistoketta (suko)
- Kaksi väriä, alumiini tai harmaa
- Kalustettavissa virtapistokkeilla (suko)
- Yhteensopiva myös jatkossa - uusia toiminnallisuuksia voidaan lisätä
- Helppo kiinnitys: portaattomasti säädettävät, liukumattomat puristimet soveltuvat 10–60 mm paksulle pöytälevylle
- Virtakaapeli (suko) 1 m, GST 18 uros



Soveltuu pöytälevylle 10-60 mm

Quality
made
in
Germany
by Kindermann

CablePort desk², 6 paikkaa



- Alumiini, eloksoitu
- Takaosa pulverimaalattu, valkoinen, RAL 9003

CablePort desk², 4 paikkaa



- Pulverimaalattu, harmaa, RAL 7015
- Takaosa pulverimaalattu, valkoinen, RAL 9003



CablePort desk²

Esiassennetut/valmiina käyttöön

CablePort desk²

6 paikkaa / Quickselect 3.0



CablePort desk² / 6 paikkaa Quickselect 3.0

Leveys	331 mm
Mitat	99 x 124 mm (H x D)
Esiassennettu	2x virta (suko) 1x VGA (HD15) 1x audio (3.5 mm stereo) 1x HDMI 1x USB type A 1x cat-6 kaikissa uros/naaras 1 m kaapeli N/U 3x stainless steel button with blue LED light ring, inkl. 3 m control line with open ends

Pulverimaalattu, harmaa (RAL 7015)

Til nro. / sn.. **7430 000 008**

Alumiini, eloksoitu

Til nro. / sn.. **7430 000 018**

CablePort desk²

4 paikkaa



CablePort desk² / 4 paikkaa

Leveys	241 mm
Mitat	99 x 124 mm (H x D)
Esiassennettu	2x virta (suko) 1x VGA 1x HDMI 1x audio (3.5 mm stereo) 1x cat-6 (RJ45) kaikissa uros/naaras 1 m kaapeli N/U

Pulverimaalattu, harmaa (RAL 7015)

Til nro. / sn.. **7430 000 004 / 7918001**

Alumiini, eloksoitu

Til nro. / sn.. **7430 000 014 / 7918004**

CablePort desk²

6 paikkaa



CablePort desk² / 6 paikkaa

Leveys	331 mm
Mitat	99 x 124 mm (H x D)
Esiassennettu	3x virta (suko) 1x VGA 1x HDMI 1x audio (3.5 mm stereo) 1x USB, 2.0 (type A) 2x cat-6 (RJ45) kaikissa uros/naaras 1 m kaapeli N/U

Pulverimaalattu, harmaa (RAL 7015)

Til nro. / sn.. **7430 000 006 / 7918001**

Alumiini, eloksoitu

Til nro. / sn.. **7430 000 016 / 7918005**

CablePort desk² 80

- helppo asennus, vain yksi pyöreä ø 80 mm reikä
- kalustetaan KF45 levyillä (7464 000 xxx)
- Saatavilla myös 2-osaisella USB-laturilla 2x2,5 A



743000252

CablePort desk² 80 alu 2 x suko



743000253

CablePort desk² 80 alu 3 x suko



743000272

CablePort desk² 80 harmaa 2 x suko



743000273

CablePort desk² 80 3 x suko



743000351

CP desk² 80 alu 1x suko + lataava 2-osainen USB



743000371

CablePort desk² 80 1 x suko + lataava 2-osainen USB



743000352

CablePort desk² 80 alu 2 x suko + lataava 2-osainen USB



743000372

CablePort desk² 80 2 x suko + lataava 2-osainen USB



CablePort desk² 80 turn

7430000201

Tuki kaapelisuojalalle (Cable snake Pro)

7430000200

CablePort desk² 80 pöytämoduulin asennettava lisäosa mahdollistaa lähes 360° (+/-150°) kääntyvän pöytämoduulin.

Helppo asennus, vain yksi pyöreä ø 80 mm reikä.

lukitusasennot 30° välein, korkeus 25 mm, -8° kalteva.

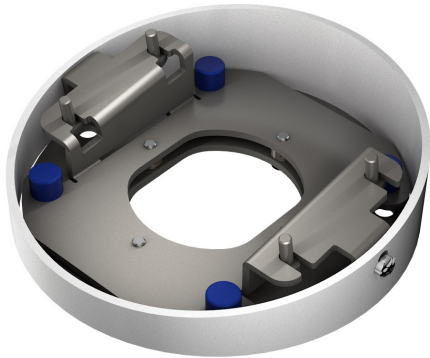

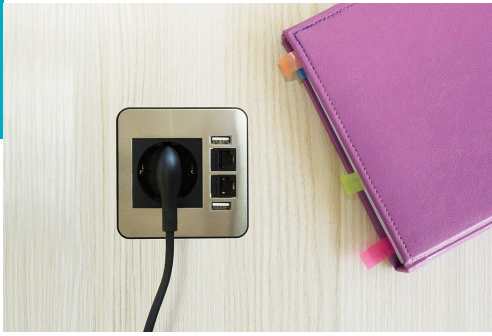

SOURCE pöytäkaivo

- vakiona 2x2,5 A USB laturia ja suko
- kalustettavissa keystone runkoliittimillä
- värit: valkoinen ja metalli
- saatavissa myös kannellinen versio
- asennusaukko Ø 80 mm

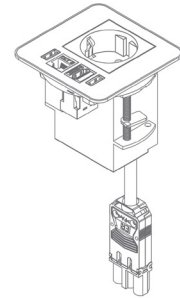
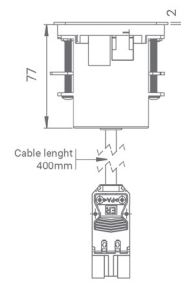
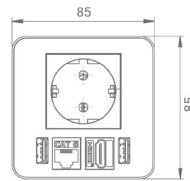

DESK UP pöytäkaivo pöydän reunaan

- kalustettavissa, 2x2,5 A USB laturimodulilla, 1-3 sukolla keystone tai 52 runkoliittimillä.
- värit: musta, valkoinen ja metalli
- pöytälevyn paksuus 8-36 mm
- UPD moduli voidaan kiinnittää pöydälle DUO kiinnikeadapterilla.

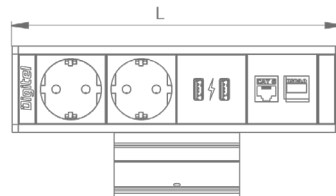
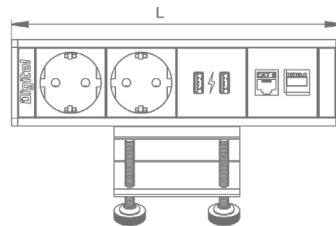
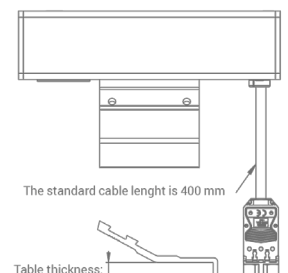
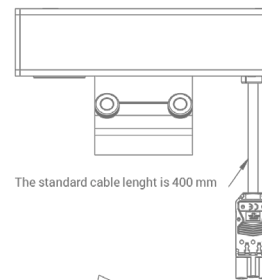
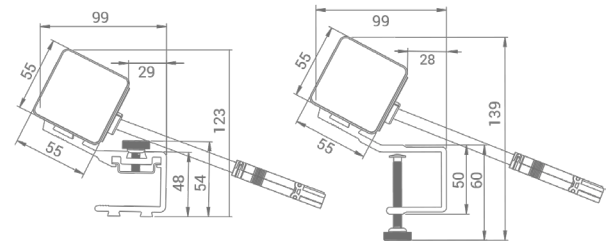

Table thickness:
min 8mm
max 28mm

Table thickness:
min 8mm
max 36mm



KOMPAKT kannellinen pöytäkaivo liitännäspisteet myös pöydän alla

- kalustettavissa, 2x2,5 A USB laturimodulilla, 1-3 sukolla keystone tai 52 runkoliittimillä.
- värit: musta, valkoinen ja metalli
- asennusaukko 93x201-360 mm

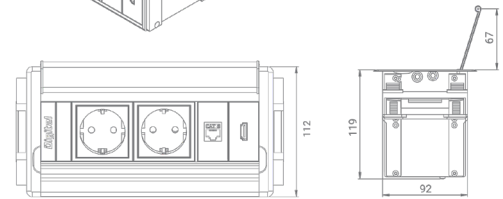
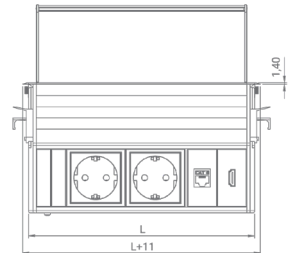
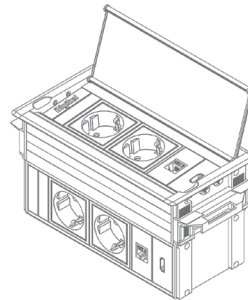

KOMPAKT S kannellinen pöytäkaivo

- kalustettavissa, 2x2,5 A USB laturimodulilla, 1-3 sukolla keystone tai 52 runkoliittimillä.
- värit: musta, valkoinen ja metalli
- asennusaukko 93x94-256 mm

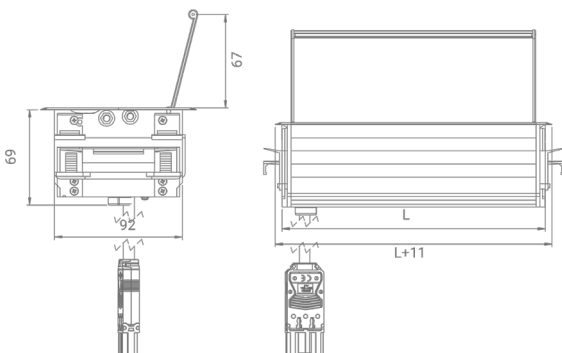
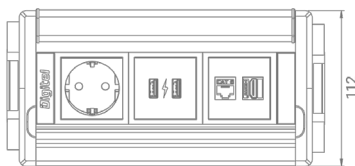



UPD moduli

- kalustettavissa, 2x2,5 A USB laturimodulilla, 1-6 sukolla keystone tai 52 runkoliittimillä.
- värit: musta, valkoinen ja alumiini



UPD base

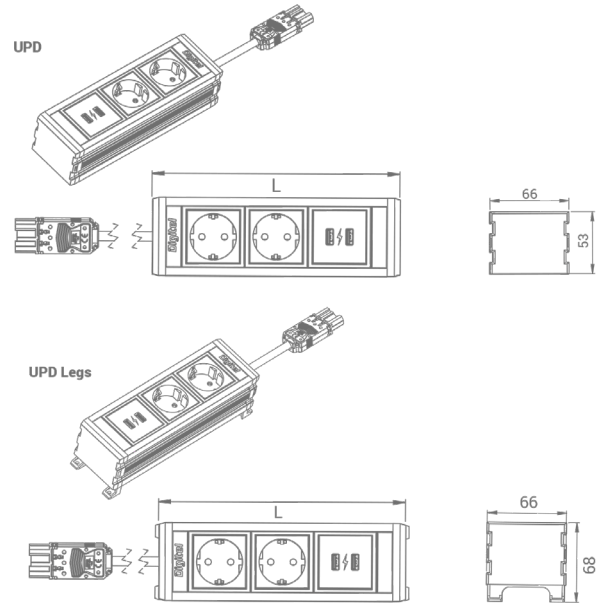
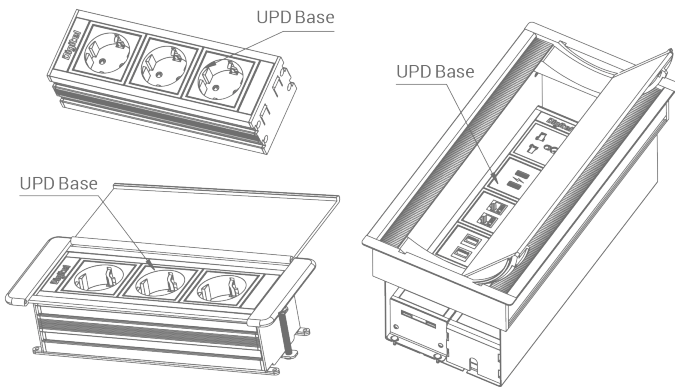
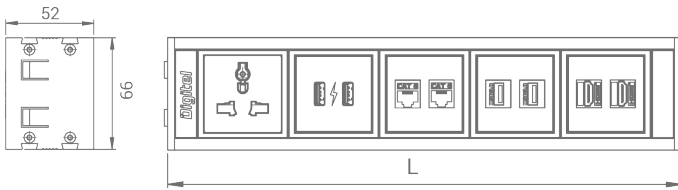

UPD moduli voidaan sijoittaa useaan Digitelin kaivoon

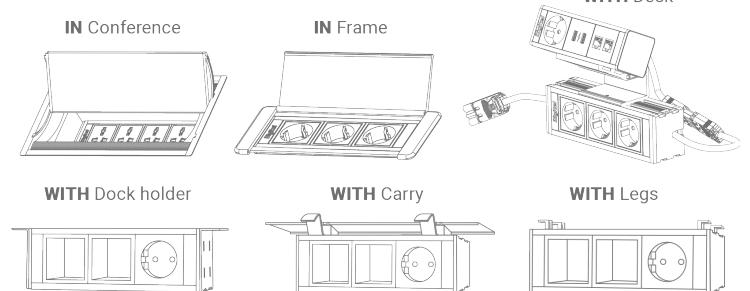

DESK UP DUO adapteri

- mahdollistaa UPD modulin kiinnittämisen pöydän alle
- värit: musta ja valkoinen



Digitel kaivot voidaan helposti kalustaa keystoneadaptereilla

- värit: musta ja valkoinen

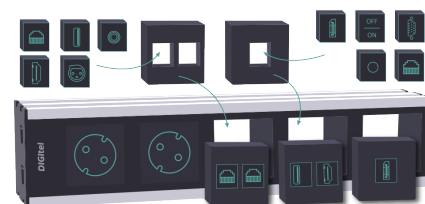



FLIP UP kannellinen pöytäkaivo

- kalustettavissa, 2x2,5 A USB laturimodulilla, 1-5 sukolla keystone tai 52 runkoliittimillä.
- värit: musta, valkoinen, keltainen, pinkki, vihreä, sininen, punainen ja metalli
- asennusaukko 142x198-378 mm

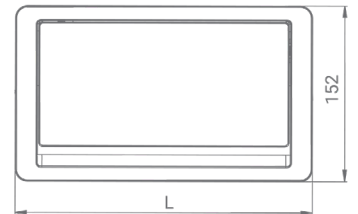
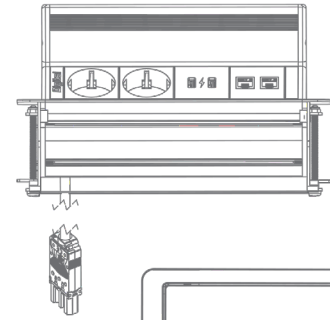
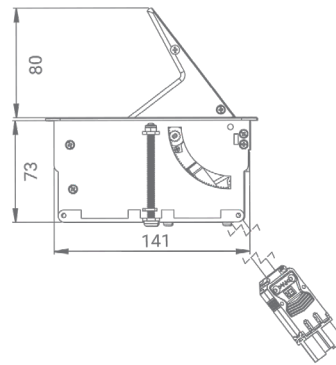

L: 211mm (3 working modules)
256mm (4 working modules)
301mm (5 working modules)

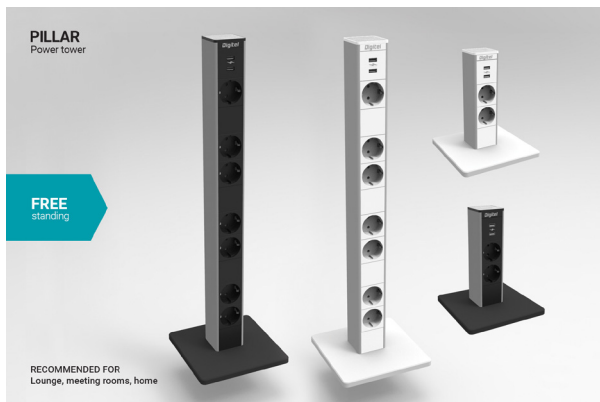

PILLAR torni

- kalustettavissa, 2x2,5 A USB laturimodulilla 2-7 sukolla värit: musta, valkoinen ja alumiini

